



EVC350/EVC950



EVC300/EVC900

EVC350 / EVC950

EVC300 / EVC900

User's Manual



TABLE OF CONTENTS

INTRODUCTION	1
Features	1
Package Contents	2
INSTALLATION	3
Getting Familiar with the EVC -Series.....	3
Main System	3
MIC	4
Camera.....	5
Remote Controller.....	6
Connections	7
Connecting Monitors (VGA Out/HDMI Out)	8
Connecting the Camera (Camera In)	9
Connecting the MIC (MIC In)	9
Connecting the LAN (RJ-45)	10
Connecting the Power (DC 12V)	10
Connecting PC (VGA in/DVI In)	10
Connecting the Audio (Audio In/Out).....	11
USB Storage (USB Ports)	12
CAMERA AND MICROPHONE INTRODUCTION	13
Using the Camera	13
Infrared Sensor (IR).....	13
Positioning the MIC	14
AVER EVC WIZARD SETUP	15
Start.....	15
Language.....	16
Site Name	16
Network Setting	16
Public IP Configuration (Outside of Firewall):	17
Private IP Configuration (behind firewall port forwarding):	18
SIP Setting.....	20
AVER EVC OPERATION.....	23
Before You Begin	23
Home Screen	23
Configuration Icons	23
Camera and MIC Icons	24
WAN Address	24
Real-Time Clock	25
System Info.....	25
Dial.....	26
Hang up the call.....	28
Video Layout.....	28
Phonebook	29
Group.....	29
New Site (Contact in Phonebook)	34
Contacts List.....	38
Favorite.....	38
Call History	39
General Setting	41
Call Settings.....	41

System Settings.....	44
Administrator.....	46
Monitor.....	50
Date and Time	51
Reset System	54
License	55
Default Layout.....	56
Video/Audio	58
Camera.....	58
Microphone.....	61
Video/Audio Codecs	63
Network.....	64
LAN Configuration.....	64
LAN Configuration (IPv6)	66
Firewall	68
SIP.....	69
SIP Configuration.....	73
Gatekeeper	77
Test.....	79
WEB CONFIGURATIONS	80
Using the WebTool.....	80
Managing Phonebook.....	82
Edit and Save	82
Download Phonebook Entries.....	83
Upload Phonebook Entries	83
System Update.....	84
Update System	84
TROUBLESHOOTING	85
Audio.....	85
Video/Display	85
Network.....	86
Others	89
SCENARIOS FOR LAN CONNECTION.....	90
Public IP Configuration (Outside of Firewall)	90
Private IP Configuration (Behind Firewall with Port Forwarding).....	91
H.460 Gatekeeper with Firewall Traversal	93
REMOTE CONTROL BATTERY SAFETY INFORMATION.....	94
LIMITED WARRANTY	95
Limitations of Warranty.....	95
Disclaimer of Warranty	95
Limitation of Liability	96
Governing Law and Your Rights	96
FEDERAL COMMUNICATIONS COMMISSION STATEMENT (CLASS A).....	97
Class A ITE	97
CE Class A (EMC).....	97
COPYRIGHT	98
Trademarks	98
Disclaimer	98

Introduction

Thank you for choosing EVC300 and EVC900 series which offer professional videoconferencing experience in new cost performance benchmark.

EVC300 and EVC900 series give you the latest technologies; slim form factor, flexible integration options and backward compatibility to most videoconferencing install bases. It makes any business meetings and special events much more reliable, effective, and secure.

Features

- ▶ EVC300/350: 4-sites embedded MCU support H.323 and SIP protocol video conferencing system
EVC900/950:10-sites embedded MCU support H.323 and SIP protocol video conferencing system
- ▶ Support full content sharing experience (send and receive) at 30fps, send content from VGA or HDMI
- ▶ Dual monitor support via HDMI1 and HDMI2/VGA
- ▶ Support CIF (352x240) up to Full HD (1920x1080 30fps) video call
- ▶ EVC300/EVC900 with PTZ camera is 16x Optics PTZ camera with 2Mp low lux sensor
- ▶ EVC350/EVC950 with PTZ camera II is 18x Total zoom PTZ camera with 2Mp low lux sensor
- ▶ Include one microphone array, much better audio pick up than competitor offering
- ▶ 10/100 and Gigabit Ethernet; video bandwidth from 64Kbps to 4Mbps
- ▶ Support IPv4/IPv6 and Wake-on-LAN (WOL)
- ▶ User-friendly on screen operation, support up to 22 languages
- ▶ Support Phonebook download, upload and edit
- ▶ Call history lookups of received, placed and missed calls, allow directly saving it to favorite contact list
- ▶ Support H.460 Gatekeeper for NAT and firewall traversal
- ▶ G.722.1C* wideband support
- ▶ Infrared (IR) remote control has power button; system supports remote API for AV integration
- ▶ Secure communication using AES 128bit encryption

*:G.722.1/G.722.1C, licensed from Polycom®

Package Contents

The following items are included in the package. Please check if each item is available before using.



- | | |
|----------------------------------|------------------------------|
| 1. Main System | 9. HDMI Cable * 2 |
| 2. Camera | 10. Camera Cable (3m) |
| 3. Microphone | 11. RJ-45 Cable (3m) |
| 4. Remote Control | 12. DVI to HDMI Connector |
| 5. Power Adapter | 13. Warranty Card |
| 6. Power Cord | 14. Quick Installation Guide |
| 7. VGA Cable | 15. AAA Batteries |
| 8. Mini Din 8 pin MIC Cable (5m) | 16. Back Panel Label |

- ☞ The power cord will vary depending on the standard power outlet of the country where it is sold.
- ☞ The camera will vary depending on choosing EVC model of EVC300/EVC350/EVC900/EVC950.

Installation

Getting Familiar with the EVC -Series

EVC includes Main System, MIC, Camera and Remote Controller.

Main System

Front Panel:

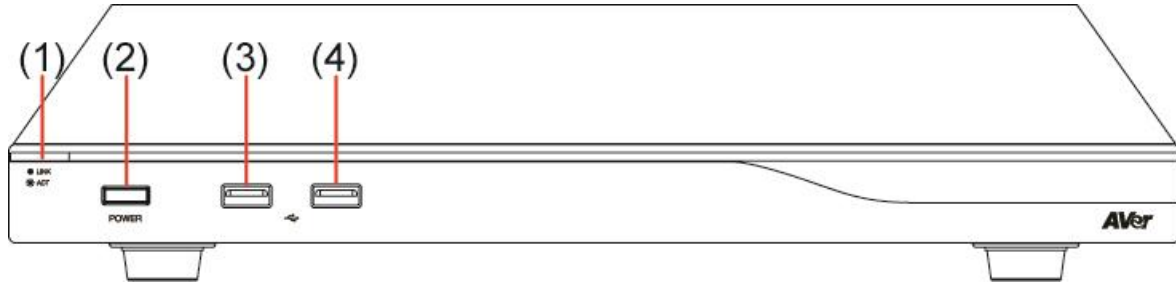

Name	Function
(1) LED Indicator	Show you the status of your LAN connection. <ul style="list-style-type: none">■ Solid Green: LAN connection is successfully■ Flash Green: Data transmission is processing through the LAN connection.
(2) POWER Button	Press this button to turn on/off main system. Red: power off; Blue: power on
(3) & (4) USB Port	Use to connect the USB storage for system log saving and FW upgrade.

Back Panel:

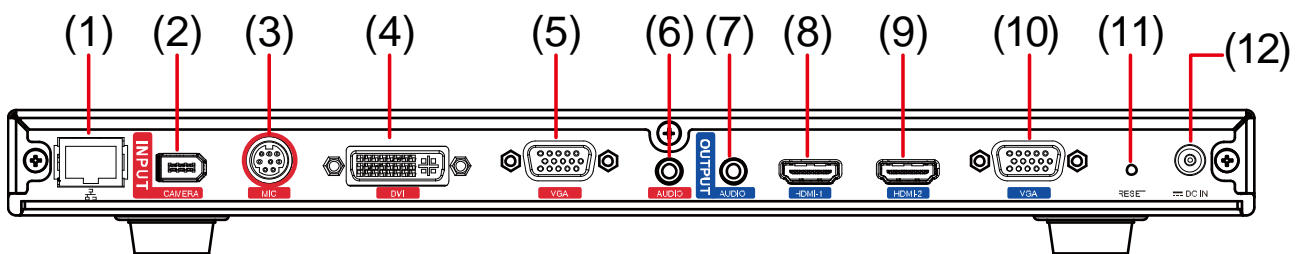

Name	Function
(1) LAN Port	Use the RJ-45 Ethernet cable to connect an IP-based network to the LAN port.
(2) CAMERA IN Port	Connect the camera to the main system via a camera cable.
(3) MIC IN Port	Receive audio signal from MIC device via a mini din 8 pin MIC cable.
(4) DVI IN Port	Using the DVI to HDMI connector to transfer the DVI to HDMI interface and through the HDMI cable connects to the PC or NB.
(5) VGA IN Port	Connect the VGA cable to the VGA input port located on the back panel, and connect the other end of VGA cable to a VGA input source (ex. Document camera, Laptop or Desktop) to input video signal.

Name	Function
(6) AUDIO IN Port	Receive audio signal from an external audio source through the audio cable.
(7) AUDIO OUT Port	Use to connect the main system to external speakers or amplifiers for audio signal output.
(8) HDMI-1 Port	Connect an HDMI cable from the HDMI monitor to HDMI-1 output port located on the back panel. The HDMI interface allows you to transmit both audio and video signals over a single cable (HDMI cable). In dual screen configuration, the output screen connected to this port will be set up to primary screen automatically.
(9) HDMI-2 Port	Connect the HDMI cable to the HDMI-2 output port located on the back panel, and connect the other end of HDMI cable to a display device to output both video and audio signal. In dual screen configuration, the output screen connected to this port will be set up to secondary screen automatically.
(10) VGA OUT Port	Connect the VGA cable to the VGA output port located on the back panel, and connect the other end of VGA cable to a display device to output video signal. In dual screen configuration, the output screen connected to this port will be set up to secondary screen automatically.
(11) RESET Button	Press it to reboot the main system unit.
(12) POWER Port	Connect the power supply cord and adapter to the power port located on the back panel. And connect the other end of the power cord to a suitable power outlet.

MIC

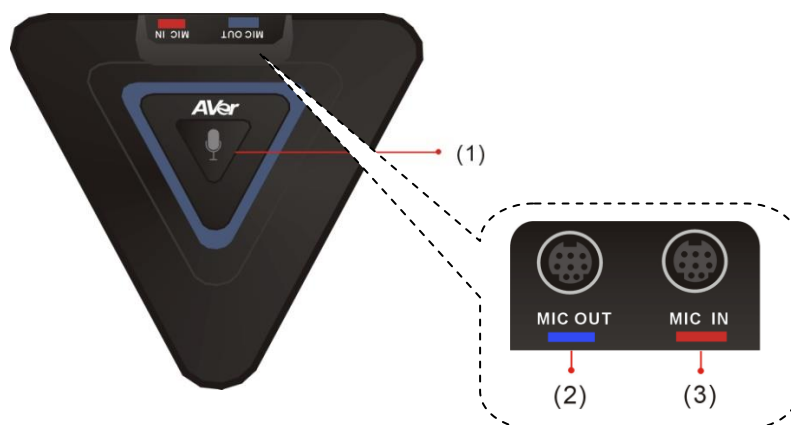

Name	Function
(1) Mute	Mute/Unmute the Mic. Blue: Unmute; Red: Mute
(2) MIC OUT Port	Outputs audio signal from the MIC to main system.
(3) MIC IN Port	Receive audio signal from the second MIC and pass it through the MIC OUT to the main system.

Camera







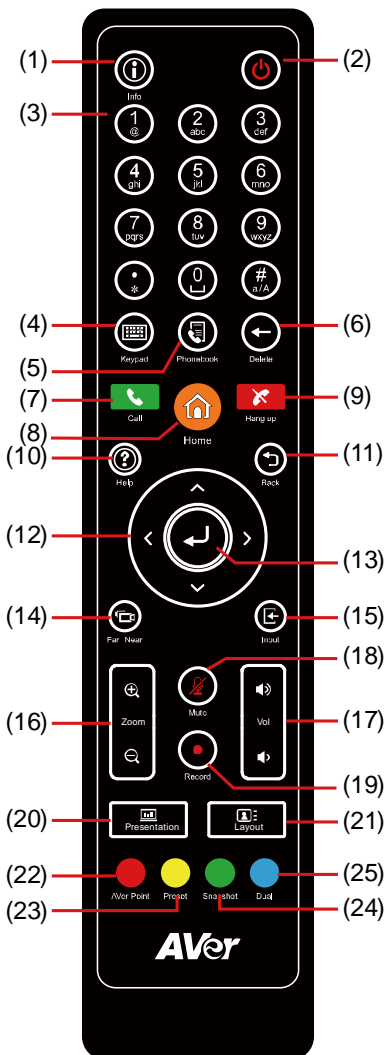

(Schematic diagram)

Name	Function
(1) IR Sensor	Receive IR signal from the remote control for system operation. Amber light blinks when it detects key pressing event from remote.
(2) CAMERA OUT Port	Connect the camera cable to the CAMERA OUT port located on the back of camera and CAMERA IN port located on the back panel of main system for a video transmission.

Remote Controller

The remote controller requires two “**AAA**” batteries (included). Make sure the batteries are installed properly before using the remote controller. Aim the remote controller at the infrared sensor of your AVer EVC camera to remote control the unit.



Name	Function
(1) Info	Press this button to display the call statistics information.
(2) Power	Press this button to power on/off the main system.
(3) Numeric Pad	Use to enter alphanumeric. Press  button and hold can switch between numeric mode and alphanumeric mode.
(4) Keypad	In enter mode, press this button to display the on-screen keyboard.
(5) Phonebook	Search contacts to make a call. Add, edit, delete or create group contact entries.
(6) Delete	Press this button to back delete one character at a time.
(7) Call	Start a call.
(8) Home	Bring up the main screen.
(9) Hang up	End the call.
(10) Help	In Home menu and video screen mode, press it to display on-screen help information.
(11) Back	Return to previous OSD menu.
(12) Navigation Buttons ( ,  ,  , )	<ol style="list-style-type: none"> Use these buttons to navigate through the selections in OSD menus or on-screen keyboard. Pan and tilt the camera to adjust the viewing. Pan, tilt the zoomed in camera image or captured image.
(13) Enter	<ol style="list-style-type: none"> Make a selection in OSD menus. Accept incoming calls. Display the site name and icon during the meeting. Auto Focus function(PTZ camera only)
(14) Far/Near	Select to control either near site or far site camera. The cam ctrl icon will appear on the screen to indicate which site's camera you are controlling. The cam ctrl icon will disappear after press the Far/Near key 5 sec.

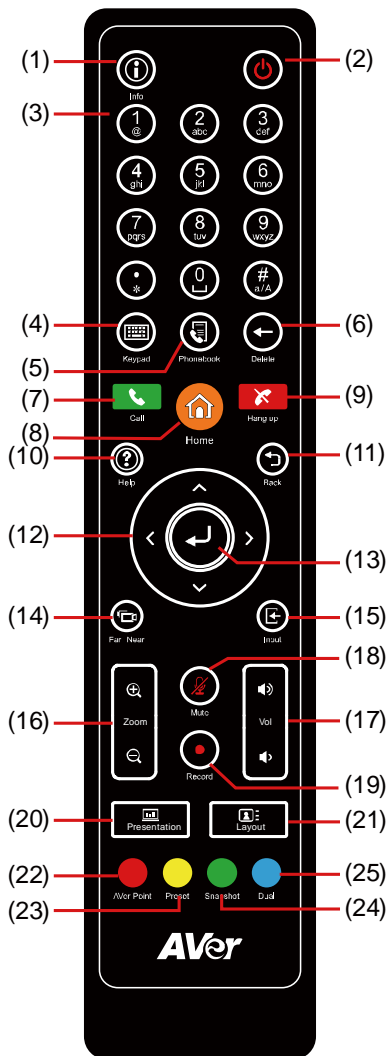

Name	Function
(15) Input	Switch screen display between camera screen and input source screen.
(16) Zoom +/-	Increase/decrease the camera zoom or the captured image magnifications.
(17) Vol +/-	Increase/decrease the speaker volume.
(18) Mute	Mute/Unmute the MIC. The mute icon will appear when the MIC is muted. The mute icon will become translucent after enabling 5 sec.
(19) Record	Start/Stop video recording. The video recording can only be saved to a USB flash drive. You do not need to be on a video conference to record.
(20) Presentation	Share the content that comes from either the VGA input source or the DVI input source. The present icon will appear on the screen when the presentation function is enabled. The icon will disappear after 5 sec.
(21) Layout	Change the screen layout.
(22) AVer Point	Support for EZDraw app, to switch the screen of a tablet for content sharing.
(23) Preset	<ul style="list-style-type: none"> a. Press and hold for 3 sec. to set the position of the camera to a preset from 0~99. b. Press to move the camera to a selected preset point number.
(24) Snapshot	Capture the image from the monitor screen. (Storage to USB flash drive)
(25) Dual	<ul style="list-style-type: none"> a. Switch to dual screen mode. This splits the video conferencing screen and present screen onto two separate monitors (two monitors must be connected to use the feature, one through HDMI and one through VGA/HDMI-2). b. Press and hold can switch to OSD menu between primary and secondary screen.

Before making the connections, make sure all devices are powered off. Refer to the illustrated connections below and also to the user manual of the device you are connecting to the EVC300 / EVC350 / EVC900 / EVC950 system.

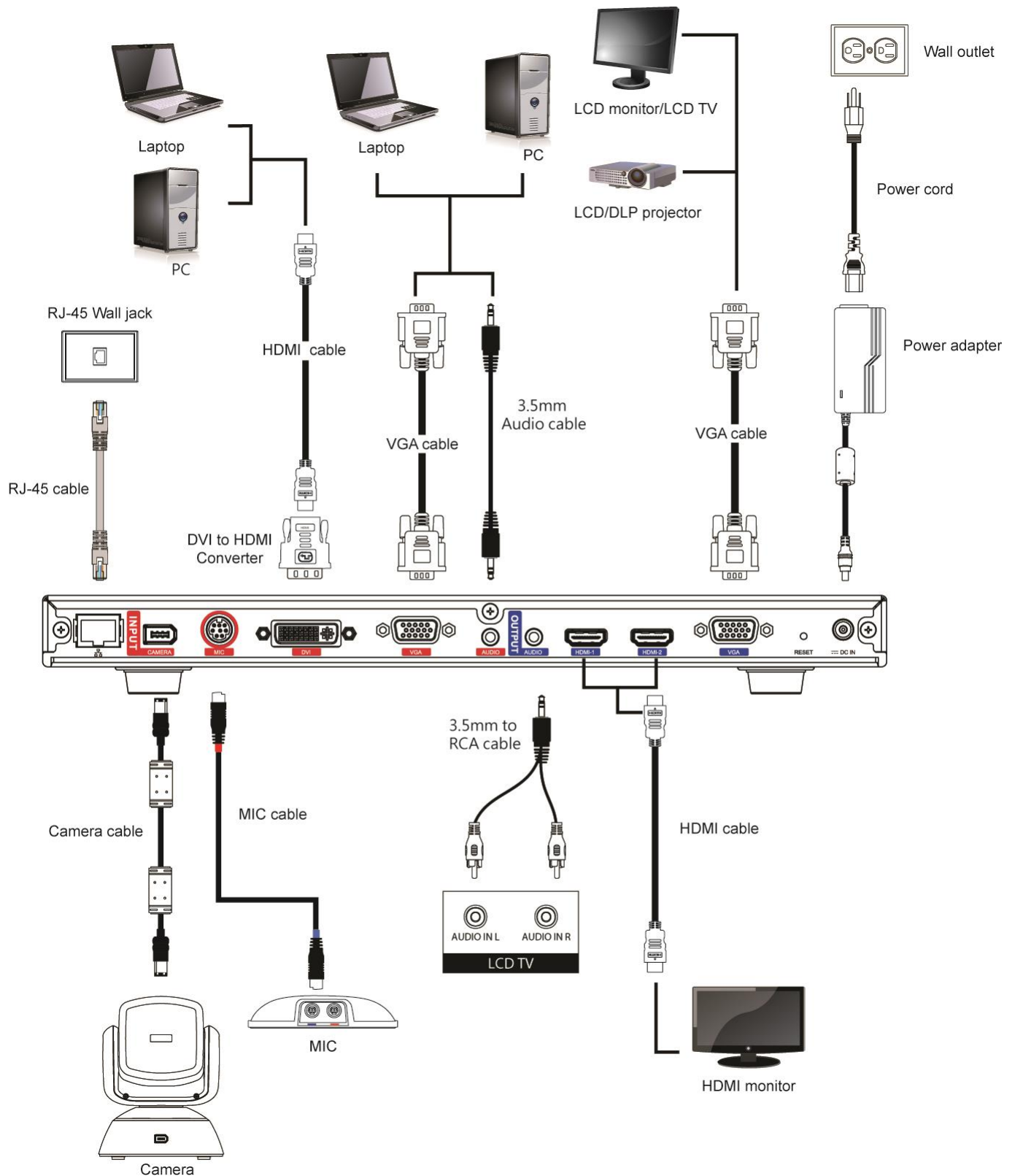

⚠ Make sure all connections have been connected successfully before powering on the system.

Connecting Monitors (VGA Out/HDMI Out)

Locate the VGA/HDMI input port of the graphics display device and connect it to VGA OUT/HDMI OUT port of the AVer EVC with the supplied VGA/HDMI cable. You can connect the VGA OUT and HDMI-1 OUT ports or HDMI-1 OUT and HDMI-2 ports at the same time upon a dual screen configuration. The HDMI-2 output and VGA output port displays screen scene and resolution are same.

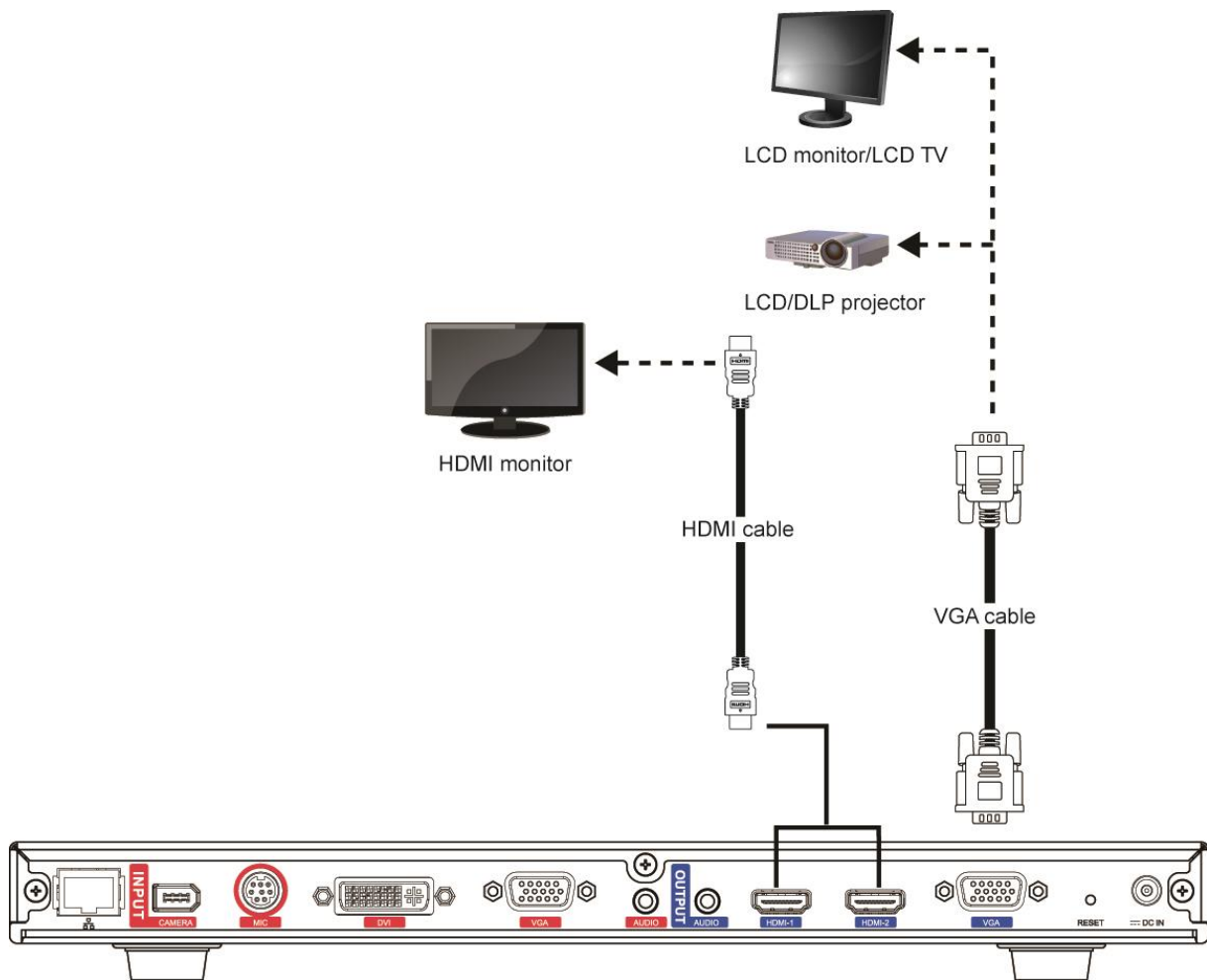

Connecting the Camera (Camera In)

Locate the port on the back of the camera and connect it to the CAMERA IN port of the EVC with the supplied camera cable.

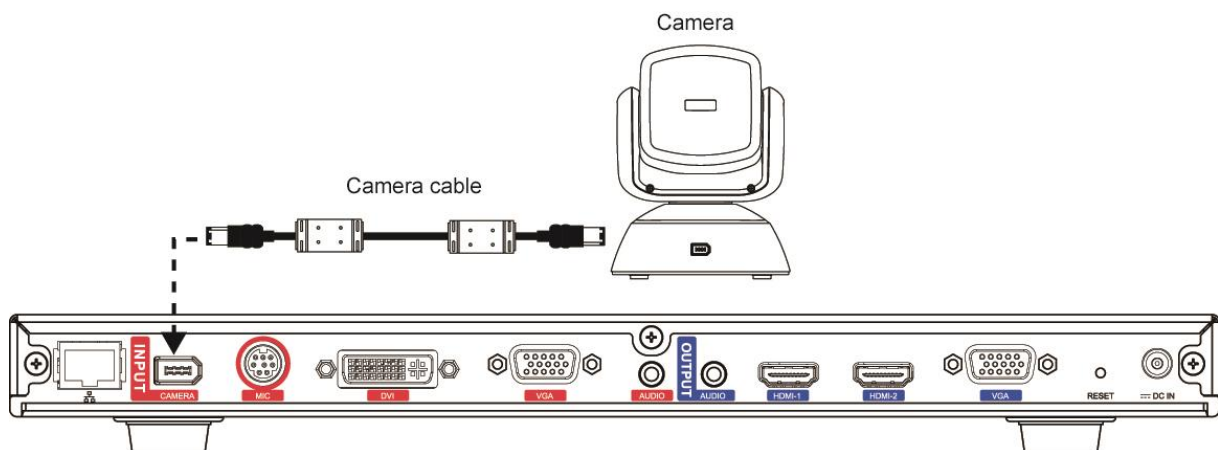

Connecting the MIC (MIC In)

Use the supplied MIC cable and connect the red tag connector to the MIC IN port of the EVC. Then connect the other end of the MIC cable with the blue tag to MIC OUT port.

- ☞ Press the button on the top of AVer EVC-MIC to mute/un-mute the MIC.
- ☞ Please connect the cable to the port follow by the color on the cable and port, ex. red to red.

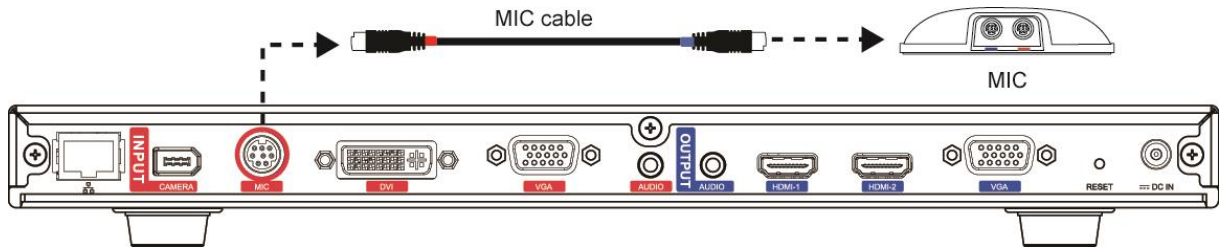

Connecting the LAN (RJ-45)

Connect the LAN port of AVer EVC to a RJ-45 wall jack or Ethernet hub with the supplied RJ-45 cable.

- ☞ It requires an IP-based network before beginning LAN connection.

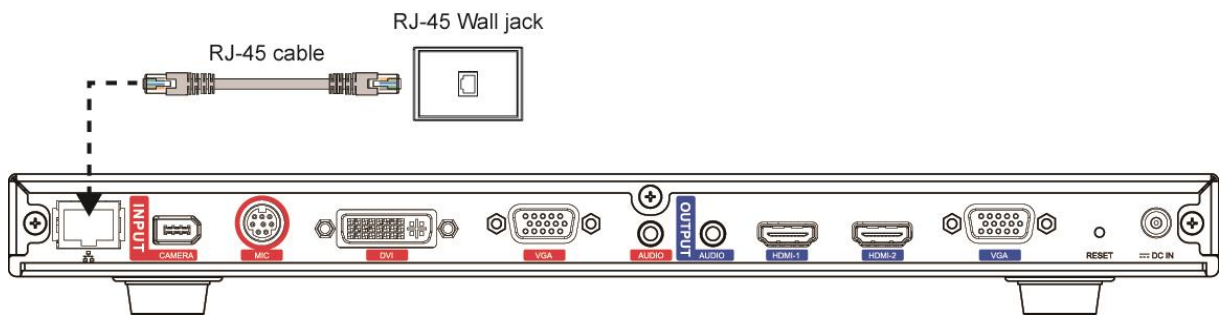

Connecting the Power (DC 12V)

Connect the power adapter to a standard 100V~240V AC power outlet with the supplied power adapter and power cord.

- ☞ (1) To prevent shock, make sure all the connections on the main system are connected successfully before connecting the power cable and turning on the power.
- ☞ (2) Make sure to use the supplied available power adapter.

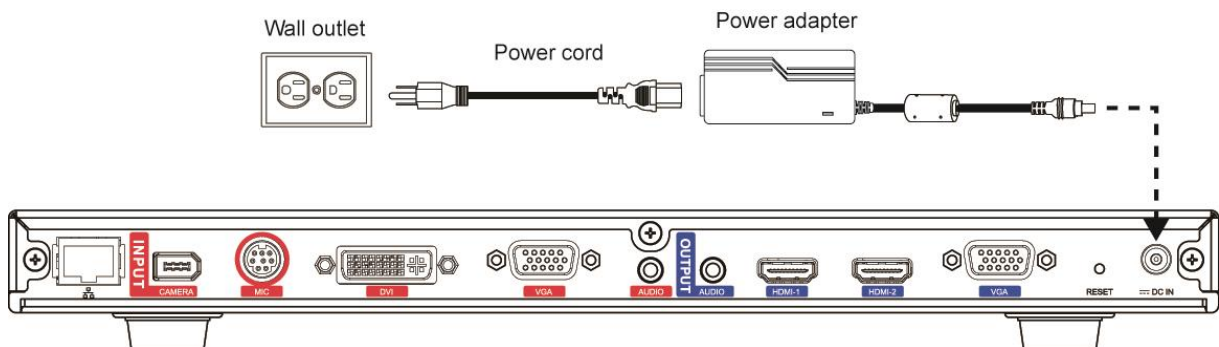

Connecting PC (VGA in/DVI In)

Locate the VGA output port of the Laptop or Desktop and connect it to VGA IN port of EVC with the supplied VGA cable for an image display.

Use the supplied DVI to HDMI connector and connect to the HDMI port of Laptop or Desktop with HDMI cable.

☞ To share the video signal from the computer, press PRESENTATION and select “VGA” or ”DVI” source.

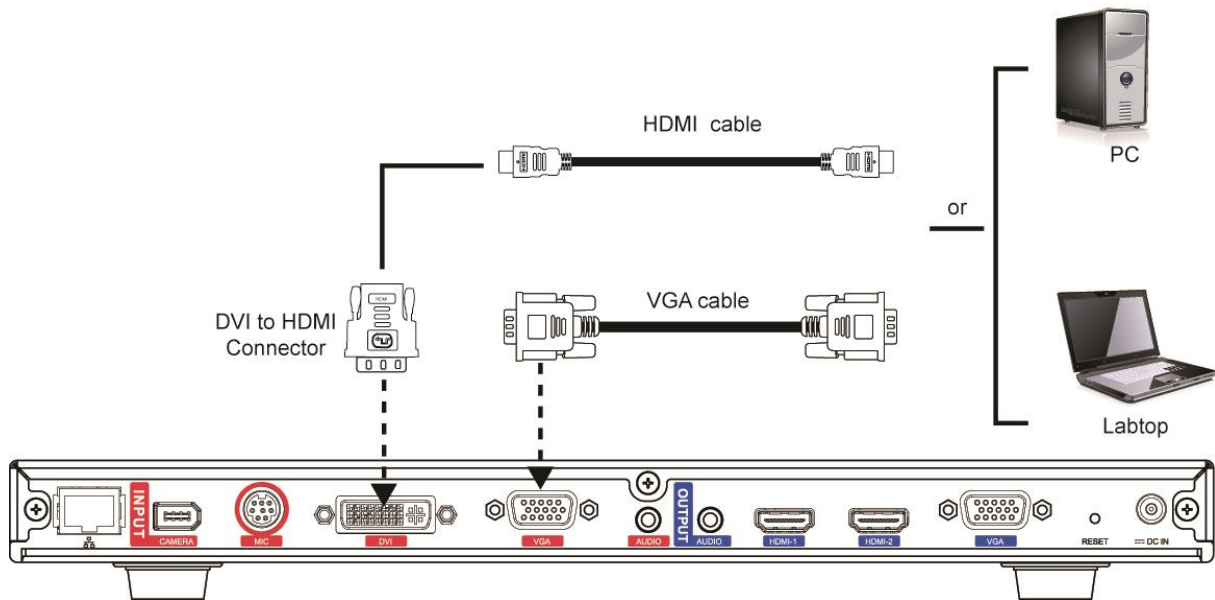

Connecting the Audio (Audio In/Out)

AUDIO IN:

Locate the AUDIO output port of the Laptop or Desktop and connect it to AUDIO IN port of AVer EVC with the supplied 3.5mm Audio cable.

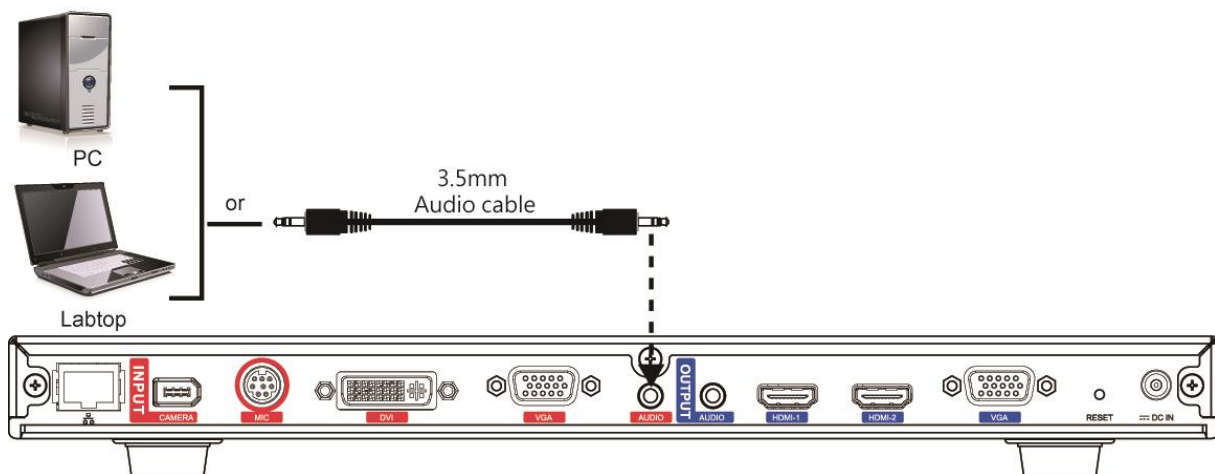

AUDIO OUT:

Locate the AUDIO in port of the LCD TV speaker or normal speaker and connect them to AUDIO OUT port of EVC with a RCA cable.

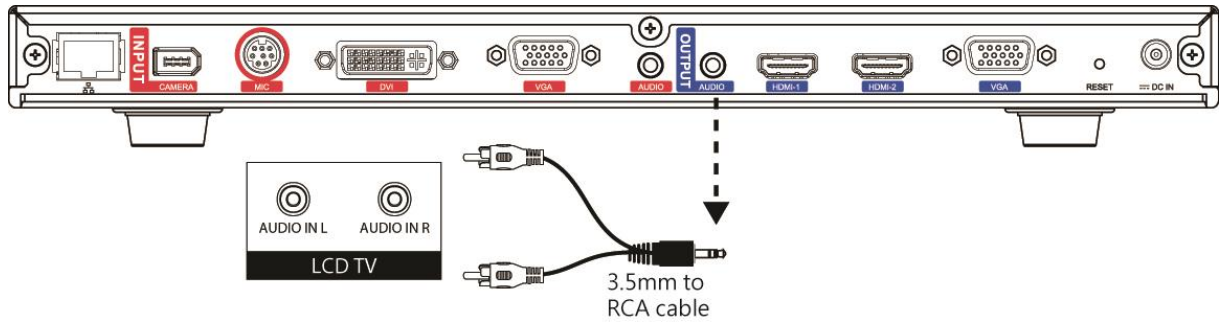

USB Storage (USB Ports)



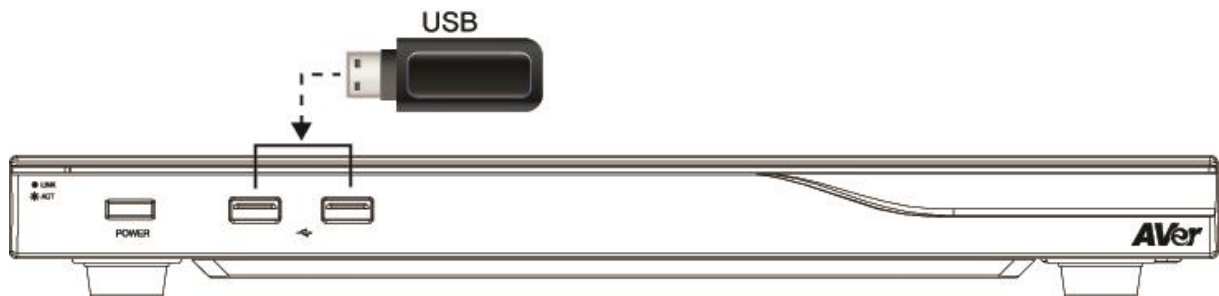





EVC main system supports two USB2.0 interface for saving data.



Camera and Microphone Introduction

This chapter explains the best way to position EVC300 / EVC350 / EVC900 / EVC950 in a conference room.

Using the Camera

- ▶ EVC300 / EVC900 includes a detached camera that can pan (\varnothing +/-100 deg. range), tilt (\varnothing +/-25 deg. range) and zoom (16x Optics) by using the , , ,  and zoom +/- buttons on remote controller.
- ▶ EVC350 / EVC950 includes a detached camera that can pan (\varnothing +/-130 deg. range), tilt (\varnothing +90/-25 deg. range) and zoom (18x total zoom with 12x Optical, 1.5x Digital zoom) by using the , , ,  and zoom +/- buttons on remote controller.

⚠ Avoid physically turn camera while system is powered on to prevent permanent damaging the motors and gears and void the warranty. Always use the remote control to pan and tilt the camera head.

Infrared Sensor (IR)

Aim the remote controller at the camera infrared sensor to operate the unit.



Positioning the MIC

The best distance for EVC-MIC to receive audio signal is within 3m. The EVC-MIC can connect up to 4 in one chain.

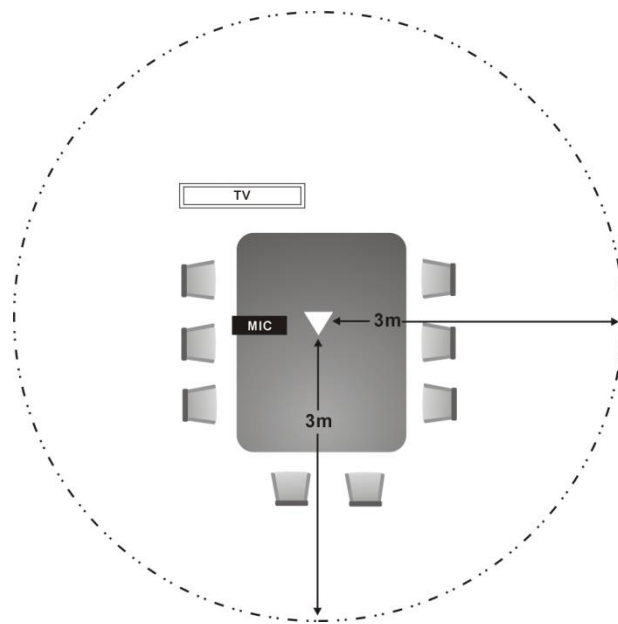

Single Microphone

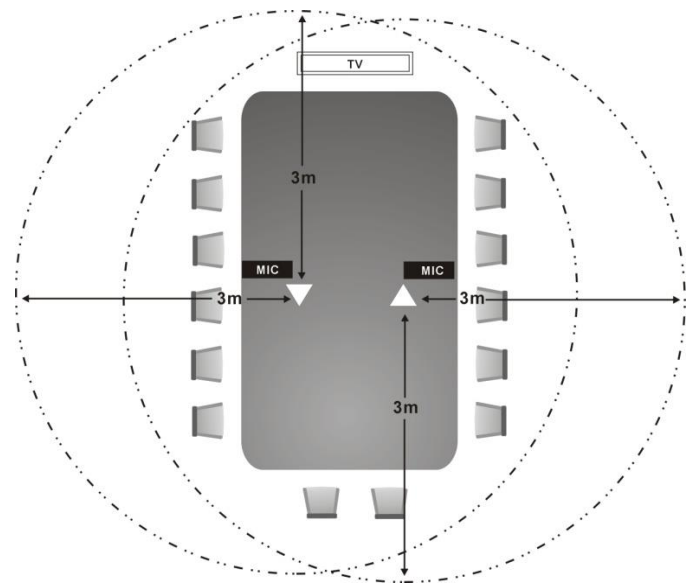
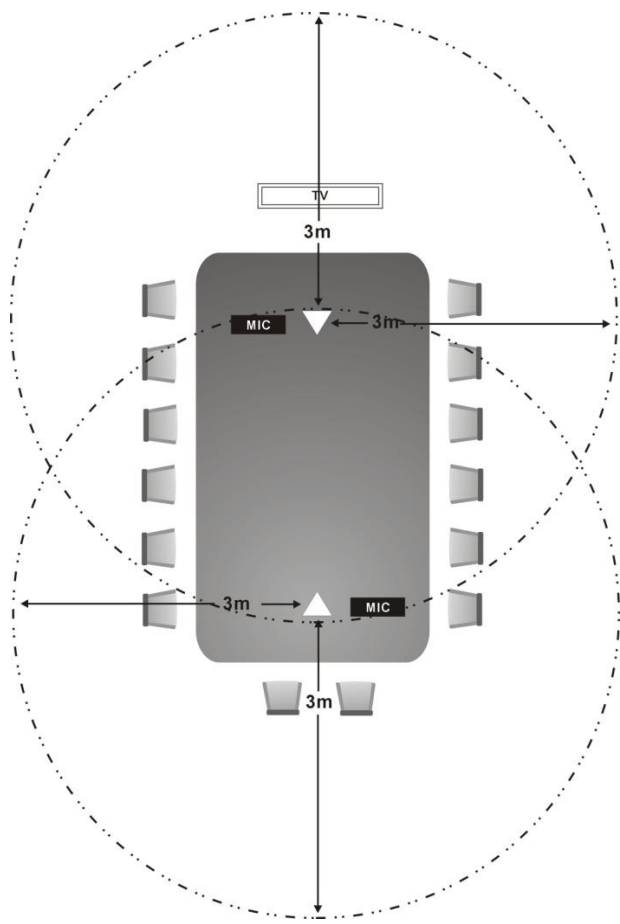



Two Microphones

AVer EVC Wizard Setup

For the first time using AVer EVC system, the Installation Wizard will guide the user to setup EVC system step by step. After completing the wizard setup, user may start to use the EVC system.

In Installation Wizard, user can use the following buttons on remote controller to move between the selections and make/confirm selection.

: To expand the drop-down list, make/confirm the selection.

/: Move the cursor up or down.

: Move the cursor to right or on **Next** button.



: Move the cursor to left or on **Back** button.

Start

Please follow the below description to complete the wizard setup.

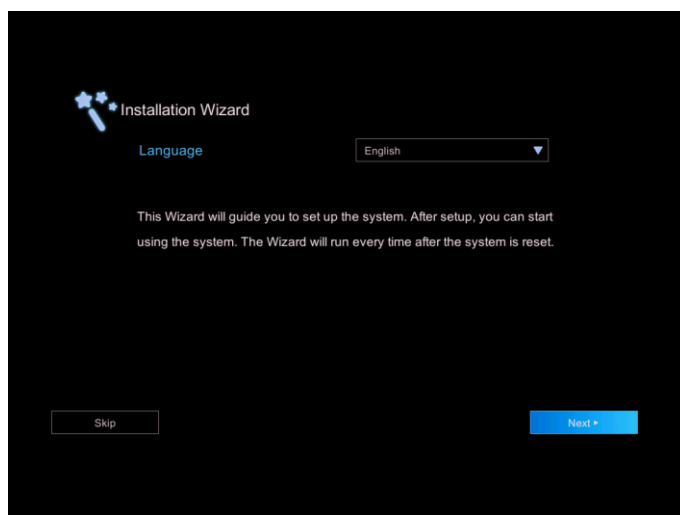
Connect your EVC system well and turn on the power. After your EVC system starting, user will see the Installation Wizard screen shown up.





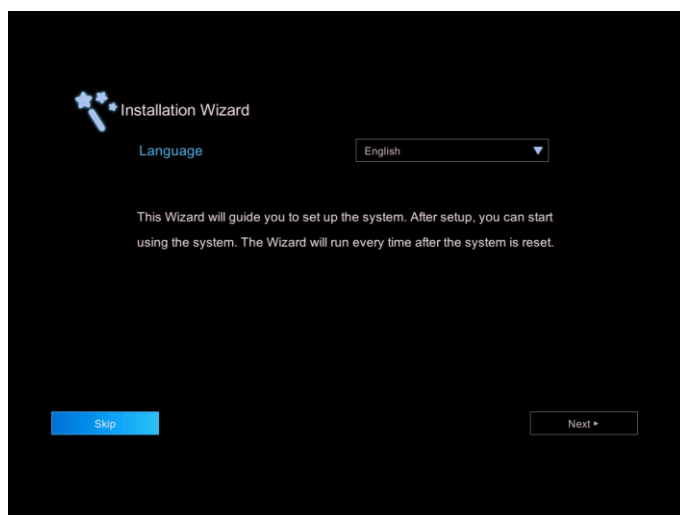



If you want to pass the Wizard setup, press  button move to **Skip** button and press  to go to Home page.



Language



Select the language of the EVC system.

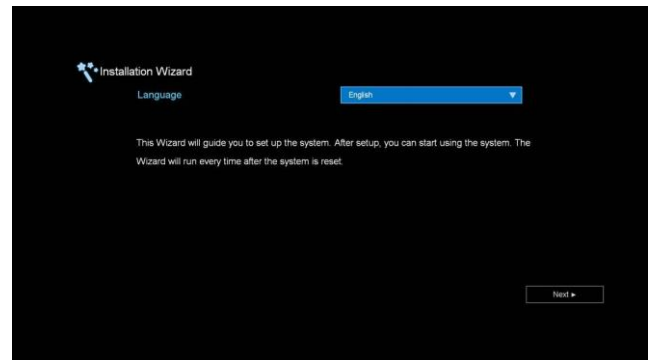

Press  to expand the drop-down list. Then, use  or  button to move the selection and press  to make the selection. After selecting, press  to move to Next option and press  to go next step.



Site Name

Assign a name for EVC system. Use the numeric pad on remote controller to enter the site name.

After entering the site name, press  to move to Next button and press  to go next step.

To go back to last step, press  to move to Back option and press  to confirm.

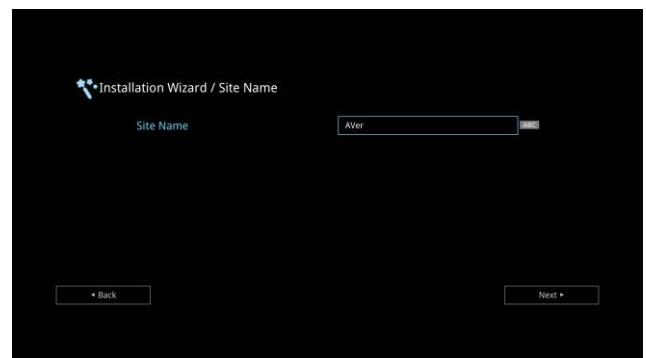

[Note]

- (1) Repeat press the number button to select the character that user wants to enter.
- (2) The site name is character only



Network Setting

Select the network environment that user has used.

Use  or  button to move to the selection and press  to confirm the selection.

[Note] User can refer to chapter of Scenarios For LAN Connection for the description of network environment.

After selecting the network setting option, user need to configure the network parameters. Follow the below description to setup the network settings.

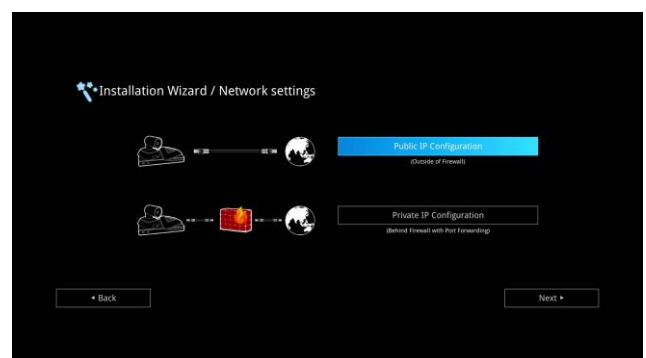

Public IP Configuration (Outside of Firewall):

Your EVC system is connecting directly to the internet. Select the IP mode.

Obtain IP address by DHCP: Configure the system to automatically obtain an IP address from the DHCP server. The EVC system will automatically get an IP address which assigned by your DHCP server on LAN. The IP address and related information will display. Click **OK** to accept the setting.

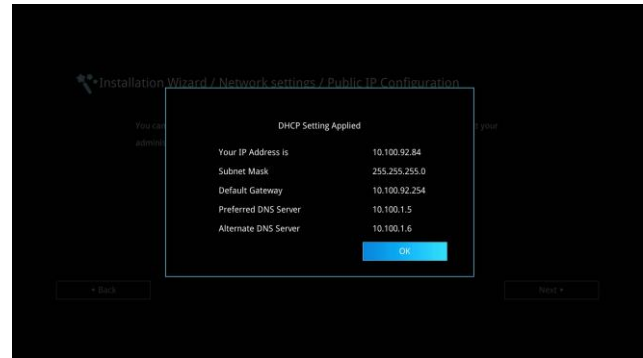
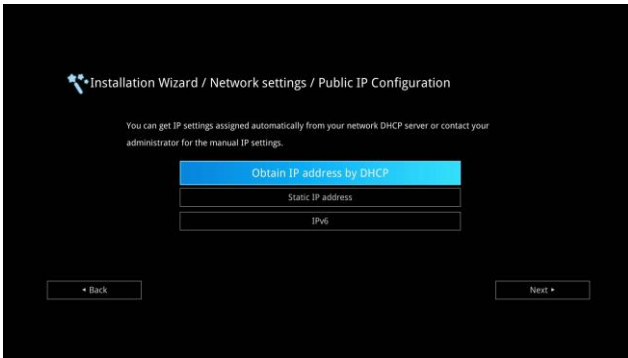

Static IP: Configure the system to use the assigned IP address. Select this when the public IP address is available.

Enter the following information and click **Apply** to save the settings. To go to next step, click **Next** and click **Back** to go back to **Network Setting** page.

1. **Your IP Address is:** Enter your IP address manually.
2. **Subnet Mask:** Enter the subnet mask address when the system does not automatically obtain the subnet mask
3. **Default Gateway:** A gateway is a network point that acts as an entrance to another network. Enter the gateway address when the system does not automatically obtain the gateway.
4. **Preferred DNS Server:** Domain Name System (DNS) servers convert human friendly names (for example: www.example.com) to IP addresses (218.77.272.166) that let machines be found on the network. The preferred DNS server is the one your computer asks first. The alternate is a backup. Enter the Preferred and Alternated DNS Server address.
5. **Alternate DNS Server:** Enter another Domain Name server for second choice.



IPv6: IPv6 is an evolutionary upgrade to the Internet Protocol. IPv6 will coexist with the older IPv4 for some time. IPv6 addresses are 128-bit IP address written in hexadecimal and separated by colons.

Select and enter the following information and click **Apply** to save the settings. To go to next step, click **Next** option and click **Back** to go back to **Network Setting** step.

1. Obtain Address is

- (1) Static IP:** Configure the system to use the assigned IP address. Select this when the public IP address is available.
- (2) Auto:** Obtain the dynamic IP address automatically. User needs to enter the IP address and prefix length in following.

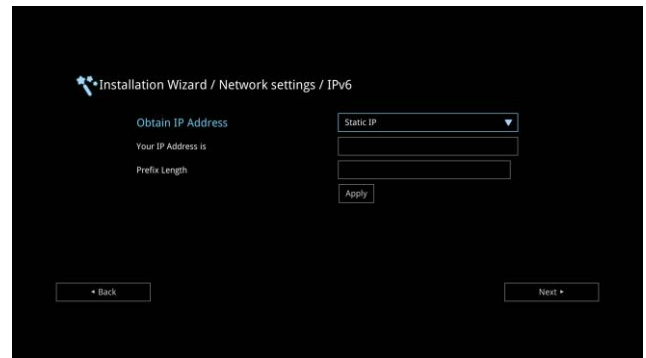

2. **Your IP Address is:** Enter your IP address manually.

3. **Prefix Length:** Prefix Length allows you to place as many IPv6 devices as the underlying network medium allows.

Private IP Configuration (behind firewall port forwarding):

Your EVC system is connecting to the internet through a firewall.

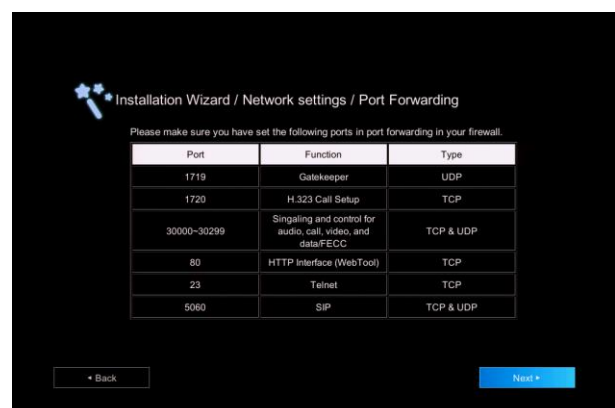
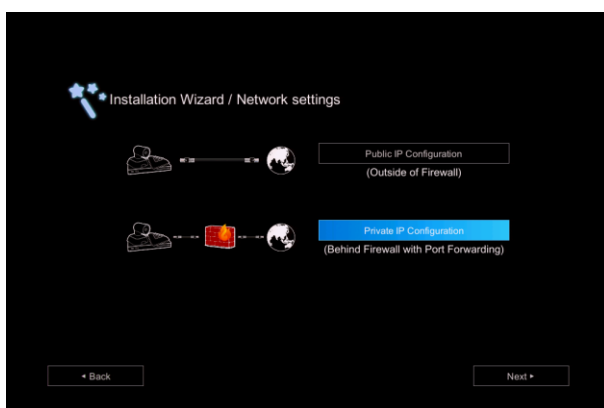

☞ Please make sure you have set the following ports in port forwarding in your firewall. Then, click Next to select the IP mode of your network

Obtain IP address by DHCP: Configure the system to automatically obtain an IP address from the DHCP server. The EVC system will automatically get a IP address which assigned by your DHCP server on LAN. The IP address and related information will display. Click **OK** to accept the setting.

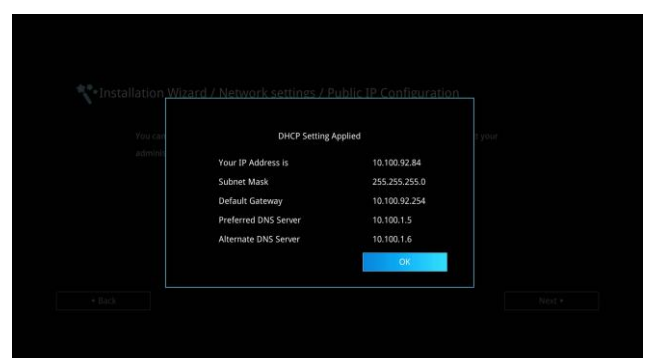

Static IP: Configure the system to use the assigned IP address. Select this when the public IP address is available.

Enter the following information and click **Apply** to save the settings. To go to next step, click **Next** and click **Back** to go back to **Network Setting page**.

1. **Your IP Address is:** Enter your IP address manually.
2. **Subnet Mask:** Enter the subnet mask address when the system does not automatically obtain the subnet mask
3. **Default Gateway:** A gateway is a network point that acts as an entrance to another network. Enter the gateway address when the system does not automatically obtain the gateway.
4. **Preferred DNS Server:** Domain Name System (DNS) servers convert human friendly names (for example: www.example.com) to IP addresses (218.77.272.166) that let machines be found on the network. The preferred DNS server is the one your computer asks first. The alternate is a backup. Enter the Preferred and Alternated DNS Server address.
5. **Alternate DNS Server:** Enter another Domain Name server for second choice.

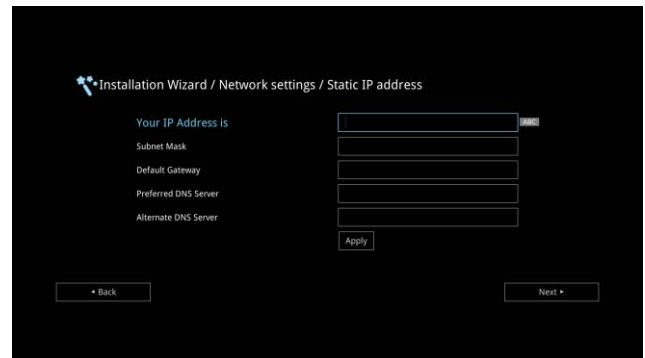

IPv6: IPv6 is an evolutionary upgrade to the Internet Protocol. IPv6 will coexist with the older IPv4 for some time. IPv6 addresses are 22 -bit IP address written in hexadecimal and separated by colons.

Select and enter the following information and click **Apply** to save the settings. To go to next step, click **Next** option and click **Back** to go back to **Network Setting step**.

1. Obtain Address is

- (1) **Static IP:** Configure the system to use the assigned IP address. Select this when the public IP address is available.
- (2) **Auto:** Obtain the dynamic IP address automatically. User needs to enter the IP address and prefix length in following.

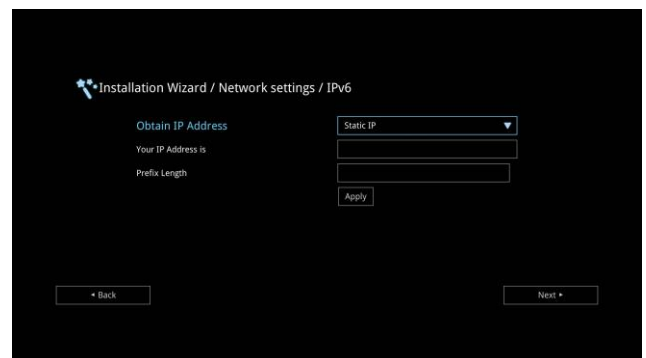

2. **Your IP Address is:** Enter your IP address manually.
3. **Prefix Length:** Prefix Length allows you to place as many IPv6 devices as the underlying network medium allows.



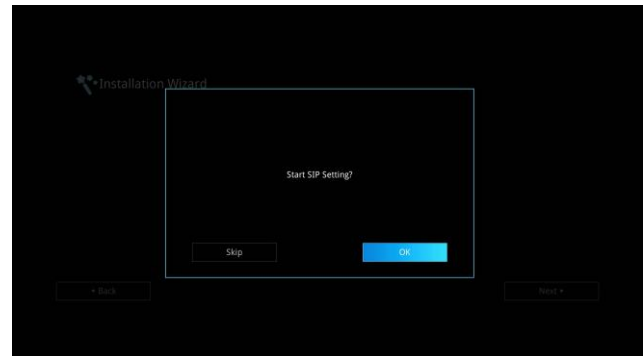
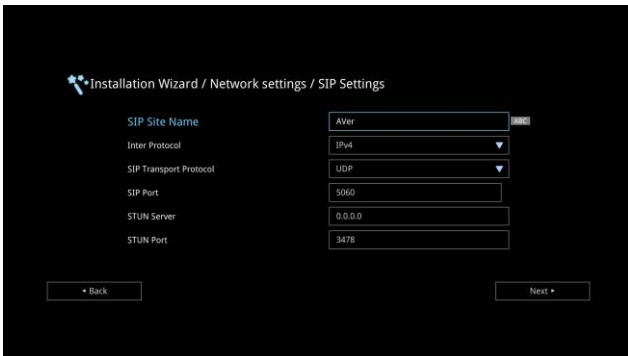

SIP Setting

Session Initiation Protocol (SIP) allows you around the world to communicate using your supported devices over the Internet. After setting network, user can choose to setup **SIP** or **Skip SIP** setting.



To setup SIP, enter or select the following information

1. **SIP Site Name:** Enter the SIP site name for others to identify. The SIP site name may be the same or different than the domain for Web activity. Use numeric pad to enter the SIP site name in column.

2. **Internet Protocol:** Select to use **IPv4** or **IPv6** as IP protocol. Press  to expand drop-down list and use ,  to move the selection. Press  to confirm the selection.

3. **SIP Transport Protocol:** Select the SIP Transport Protocol type from the drop-down list for using. There are two types of Internet Protocol (IP) traffic. They are Transmission Control Protocol (TCP) and User Datagram Protocol (UDP). To ensure proper connection, verify if both calling parties are using the same transport protocol. By default, it is set to UDP.

(1) **TCP:** TCP is connection oriented. Once a connection is established, data can be sent bidirectional.

(2) **UDP:** UDP is a simpler, connectionless Internet protocol. Multiple messages are sent as packets in chunks using UDP.

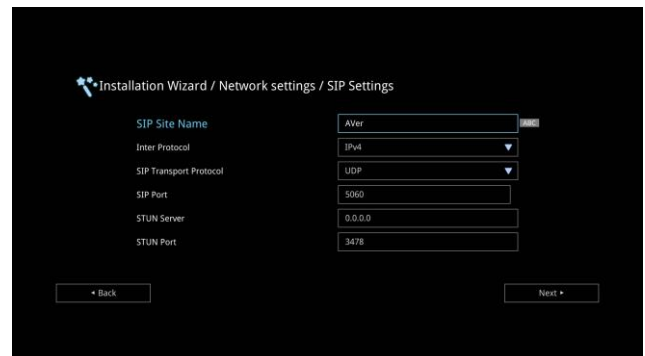

4. **SIP Port:** Change this value only if you use specific settings in your network system. By default, the SIP port is set to 5060.

5. **STUN Server:** STUN (Session Traversal Utilities for NAT) is a standardized set of methods and a network protocol to allow an end host to discover its public IP address if it is located behind NAT.

6. **STUN Port:** Enter the port number of STUN server.

SIP Server Registration

A typical SIP session involves a client requesting a session with a SIP server. After the request is received, the SIP server returns a response to the user indicating the availability of the session. After setting SIP, user can choose to setup **SIP Server Registration** or **Skip**.

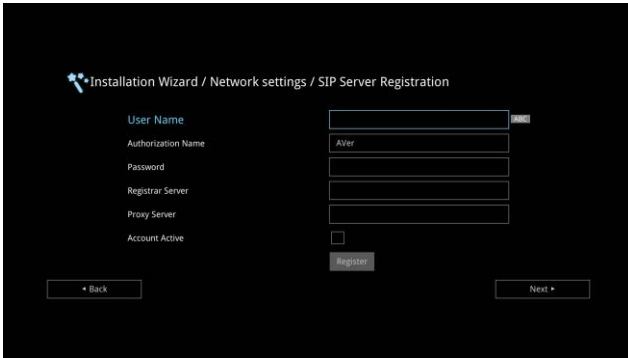

The screenshot shows the 'Installation Wizard / Network settings / SIP Server Registration' screen. It features a list of configuration fields on the left: 'User Name' (empty), 'Authorization Name' (filled with 'AVer'), 'Password' (empty), 'Registrar Server' (empty), 'Proxy Server' (empty), and 'Account Active' (checkbox, unchecked). A 'Register' button is positioned below the 'Account Active' checkbox. At the bottom, there are 'Back' and 'Next' navigation buttons.

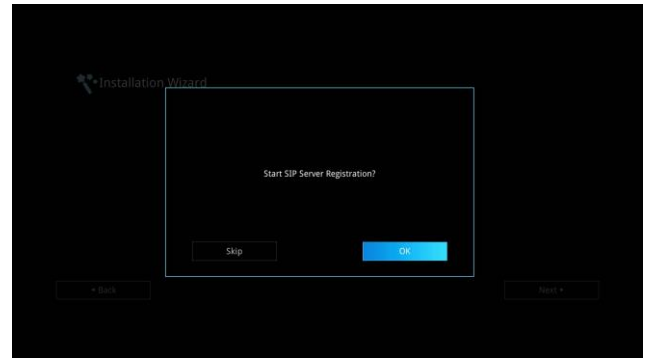

The screenshot shows a dialog box titled 'Start SIP Server Registration?'. It contains two buttons: 'Skip' and 'OK'. The 'OK' button is highlighted in blue. The dialog box is centered on the screen, with 'Back' and 'Next' buttons visible at the bottom.

To setup SIP Server Registration, enter the following information and click **Register** to save the settings. After completing, click **Next** to go next step.

1. **Terminal Name:** Enter the terminal server name.
2. **Terminal Password:** Enter the password of terminal server.
3. **Registrar Server:** Registrar Server accepts registrations from users and places these registrations, (which is essentially location information), in a database known as a location service. Enter the Registrar Server name that you want to use.
4. **Proxy Server:** Proxy Server is computing device (typically a server) that interfaces between data processing devices and others within a communications network. These devices may be located on the same local area network or an external network. Enter the used Proxy Server name.

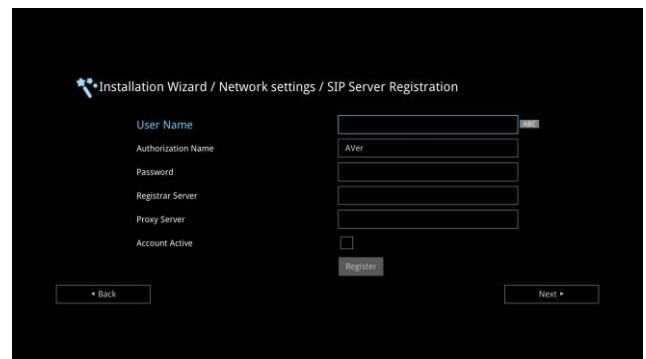

The screenshot shows the same 'Installation Wizard / Network settings / SIP Server Registration' screen as in the first image. The 'Register' button is now highlighted in grey, indicating it is the active button. The 'Next' button is also visible at the bottom right.

Date and Time Setting

Setup the EVC system date and time. User can choose to use NTP server to adjust the date/time or manually enter the current date/time.

Network Time Protocol (NTP)

Network Time Protocol (NTP) is a protocol that is used to synchronize system clock times in a network of device.

- 1. NTP Server:** The Network Time Protocol (NTP) allows administrators to synchronize all network computers to a main server. This keeps all network machine clocks on the same time. Enter the NTP Server name that you want to follow.
- 2. Time Zone:** Timezone allows you to adjust the time when you are in a different country or area so that you can keep the same time with your original area. Most of the time zones on land are offset from Coordinated Universal Time (UTC) by a whole number of hours (UTC-12 to UTC+14)

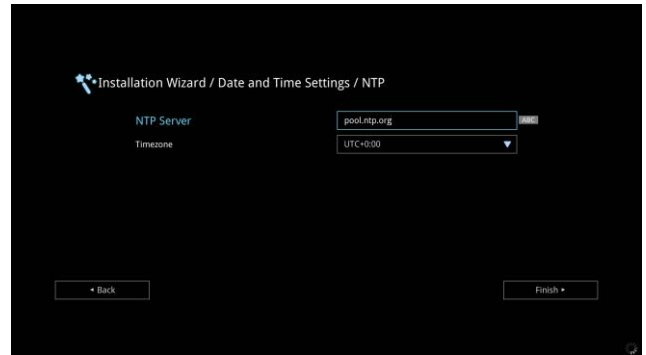

Manually Setting

Enter the present year, month, date, hour, minute, and second by yourself

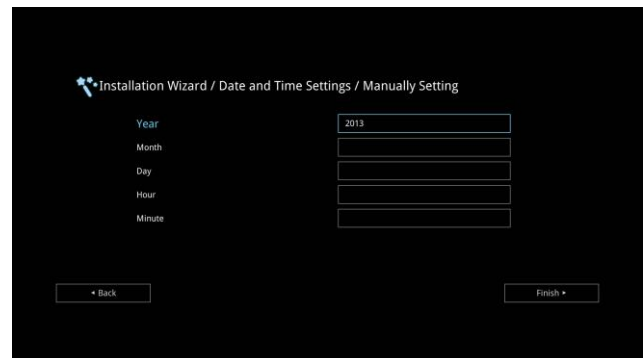
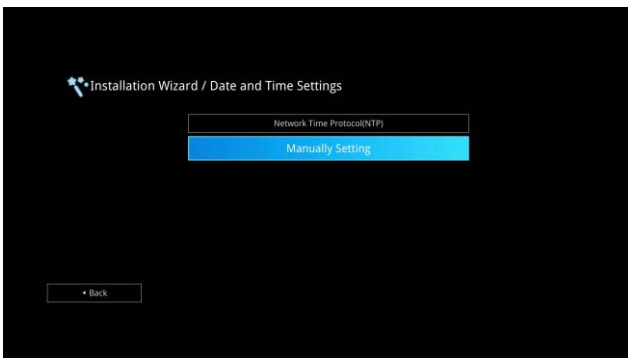

After completing date/time setup, click **Finish** to complete the Installation Wizard setup. Before that, user can back to previous page or go to home menu. How to dial a call; refer to chapter of **Making a Call**.

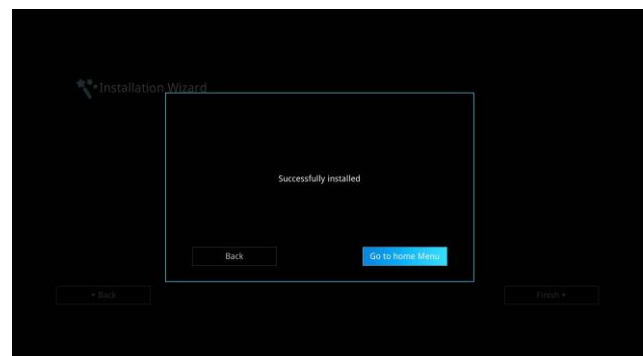

AVer EVC OPERATION

Connecting the camera, microphone, main system, display and power, press the power button to turn on EVC. Power button starts blinking blue light, AVer logo shows up followed by an animation and music. In 30 seconds camera image and home screen appear on screen. Aim the remote controller to camera and start configuring AVer EVC.

Before You Begin

Basic Operation

Navigation buttons: Use the , ,  and  buttons to move the selection on the remote controller.

Enter button: Use the  to confirm the selection on the remote controller.

Apply: Make the changed value to take effect. (For EVC Application)

Save: Accept the created value and save it to the system.

Cancel: Cancel the changed value and exit the present screen.

Home Screen

There are 2 selections divided on the Home screen: **Call** and **Setting**. Simply use the navigation buttons to move between selections and press  to confirm the selection. You can easily place a call and select the site contact either in **Dial**, **Phonebook** or **Call History**. You can easily setup up the system in **General Setting**, **Video/Audio**, and **Network**. The administrator can set a security password to prevent changes made to the system setting and WebTool access.

Configuration Icons

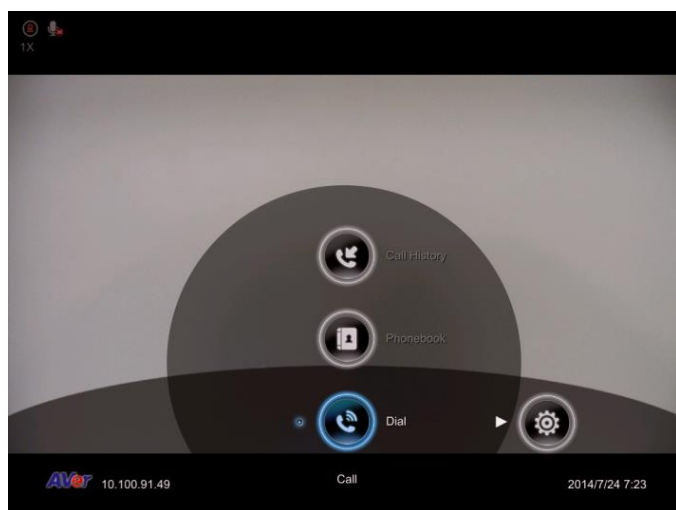

Call include Dial, Phonebook and Call History

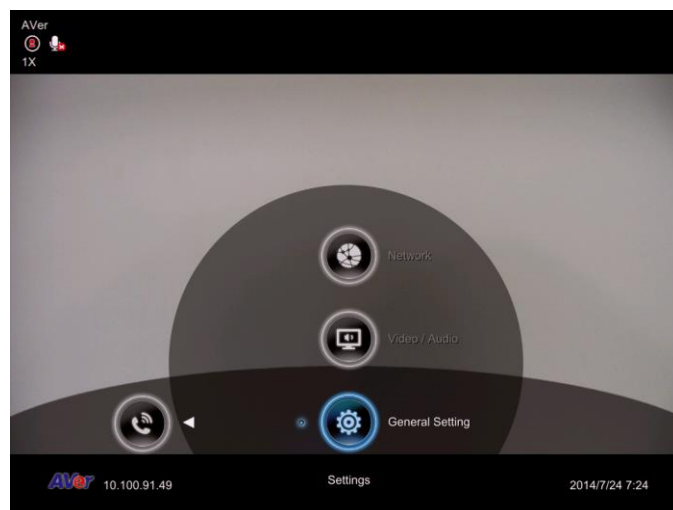

Setting include General Setting, Video/Audio and Network.

Menu function is divided into 2 parts – **Call** and **Setting**.

Call function is included **Dial**, **Phonebook** and **Call History**.

Setting function is included **General Setting**, **Video/Audio**, and **Network**.

Camera and MIC Icons

On the upper left-hand corner of your home screen, you may see camera and MIC indications.

When camera is removed, “**Camera Disconnected**” warning message is displayed and screen is blue.

When  is displayed on that screen, it means far site remote can be operated by remote controller.

 is displayed indicating microphone is mute. Try pressing the mute button on microphone or remote controller to unmute it (LED indicator on microphone turns blue).



WAN Address

On the lower left corner of your home screen, you can find current WAN IP address.



Real-Time Clock

On the lower right corner of your home screen, you can find the current Date and Time once system sets up properly.



System Info

Press **(i)** (Info) button to switch to system information page.

The System Info shows you the relative information about your EVC main system including Site Name, Model name, Maximum Allowable Sites, IP Address, MAC Address and System Version.

Also, you can view call status while call is connected.

1. Make a call.
2. When call is connected, press **(i)** (Info) button.
3. Select the call and you should see the current call status.

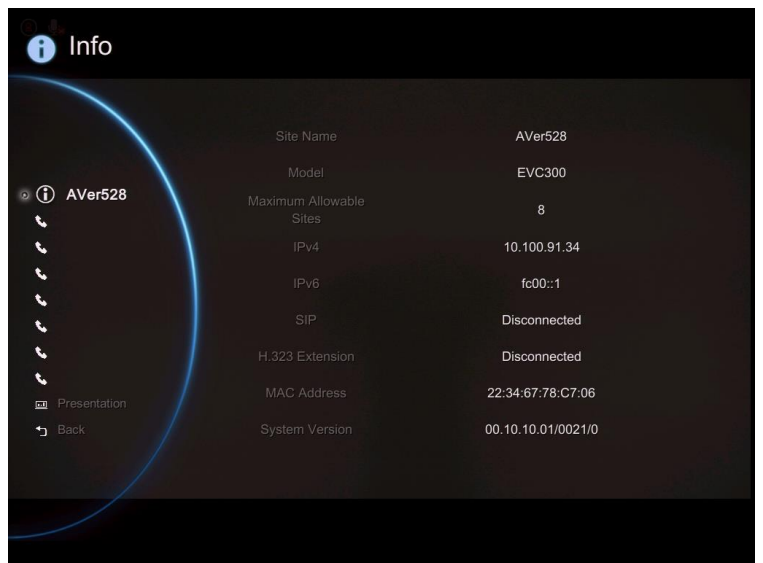

Dial

Dial selection allows you to enter dial screen and make a call.. Press  button on the remote controller has the same effect.





IP Address

Use the number keys on the remote controller to enter the IP address or number or SIP URI (sip:username.password@host) you want to call. AVer remote controller supports alpha-numeric operation, press numeric key multiple times to select the alphabet or symbol.

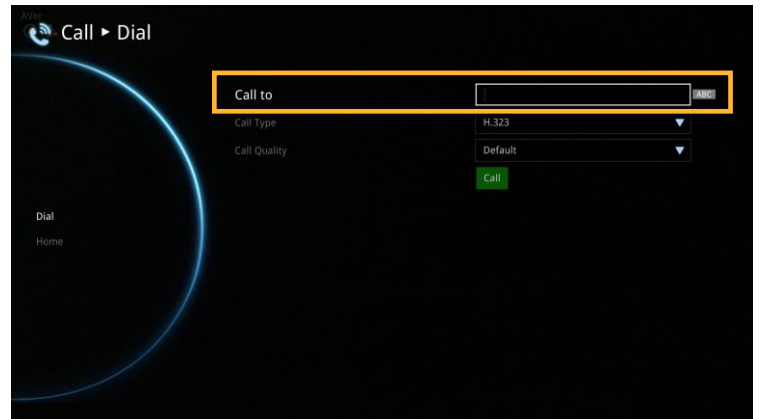
[Note] Press  button and hold can switch between numeric mode(123) and alphanumeric mode(ABC/123).



Call Type

AVer EVC supports H.323 and SIP calls. H.323 is commonly used to communication to other videoconferencing room systems. SIP is commonly used to communicate with other VoIP devices. Use the  button to select which type of call type you want to make then press  to confirm.

[Note] H.322 and SIP call type can be existed in a same conference call meeting.

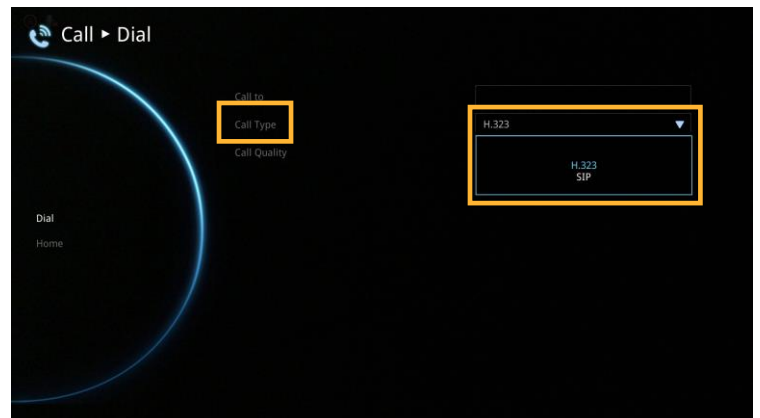

Call Quality

For the **Call Quality** selection, enter the desired call quality (or network bandwidth) from the drop-down list (default or 64K up to 4M bit per second).

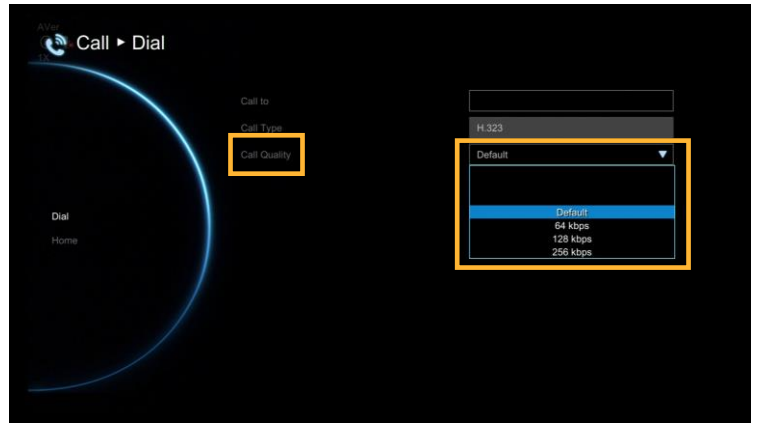



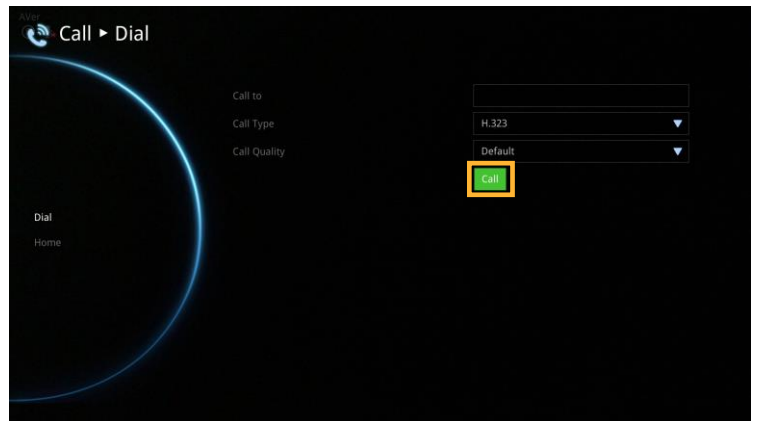

Select the **“Call”** on the Dial configuration screen then press  to make a call.

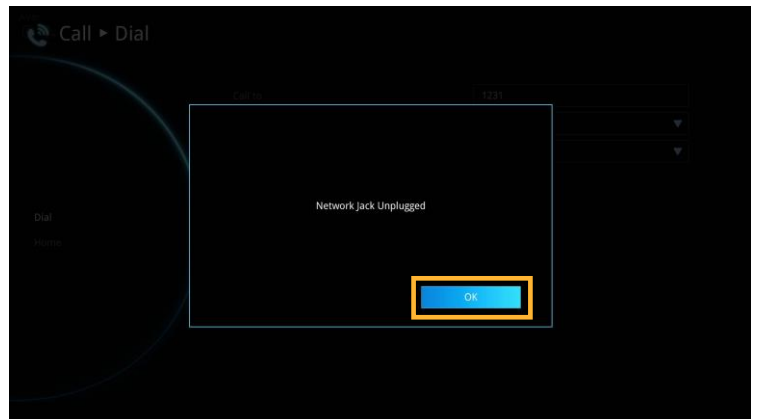

Make sure the network jack is plugged in and network is working properly before making a call; otherwise, the **“Network Jack Unplugged”** information will appear. Click **“OK”** to reconfirm the network connection.







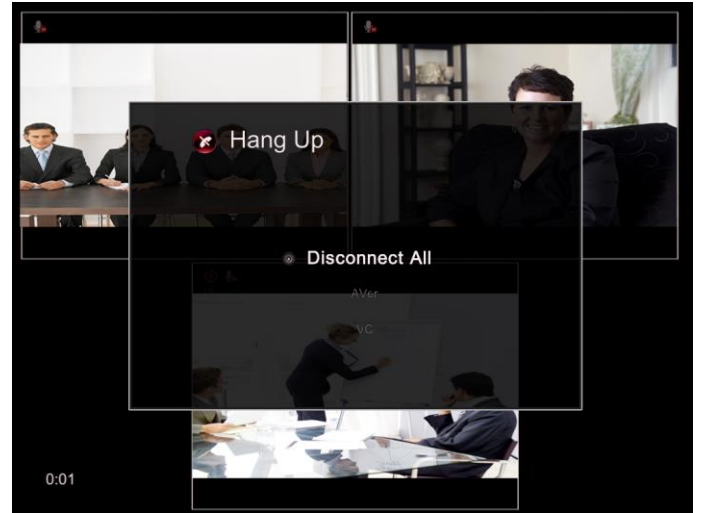





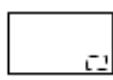





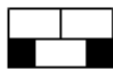





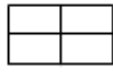
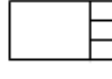
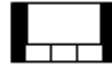
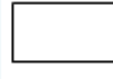
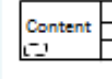

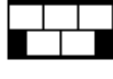
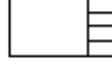

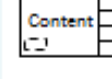









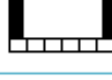



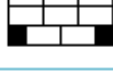







Hang up the call

1. When in multi-point call conference, press  button (Hang up) on remote control and a call-point list screen is pop-up.
2. Use the  and  buttons to select which you want to disconnect and press . To end the meeting, select Disconnect All.
3. You will notice the site names in the meeting are color coded. If you are not sure of which name you want to disconnect, refer to the color of the frame.
4. In multiple call conference, you can choose to hang out which call.



Video Layout

Video layout on multisite connections is shown as following figure:

Video layout on multisite connections						
Layout Sites	1	2	3	4	5	6
2						
3						
4						
5						
6						
7						
8						
9						
10						

Phonebook

Phonebook allows you to create and edit contact information, group contacts by category, search contacts then make a call. The group and contact (site) name in the directory will be sorted in alphabetical order. You may use the WebTool to edit or import the phonebook entries too.



Group

Select **Phonebook** and press .

Select **Group** and press .

If you have lots of contacts, it is better to categorize them to groups such as client, vendor, company, branch, etc. to make the lookup easier.

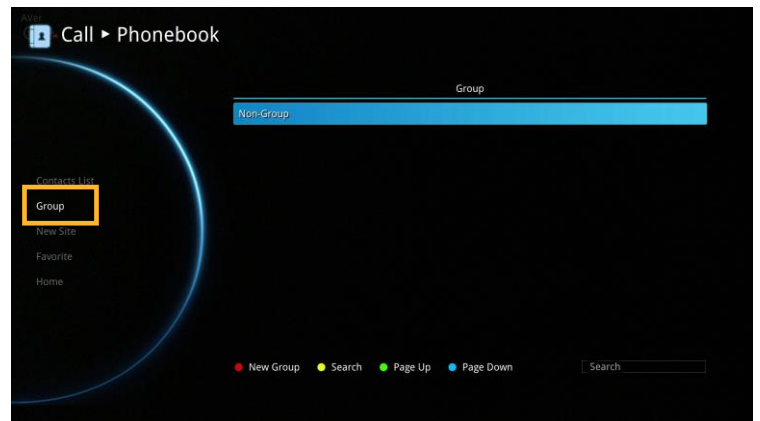

Create a New Group

In the **Group** configuration screen, Press **“Red”** button on the remote controller to pop up the **“Input Group Name”** dialogue box.

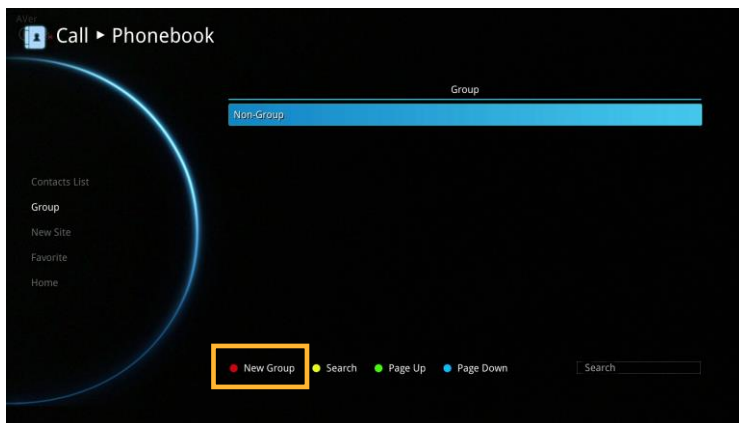

Enter the group name that you want to create.

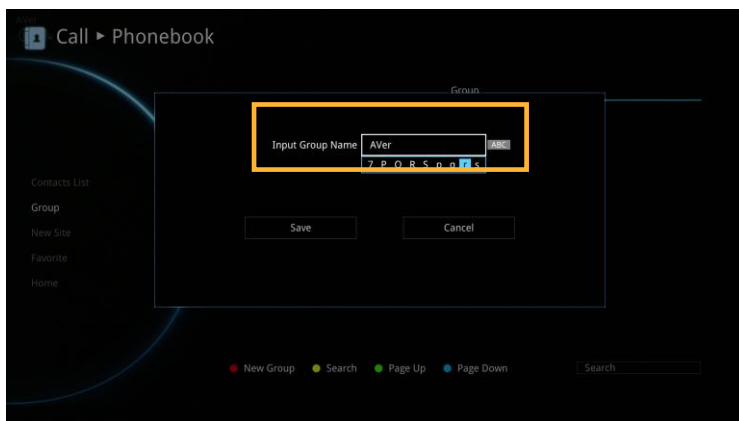

Select **“Save”** to save the new group. Or select **“Cancel”** to exit the **“Input Group Name”** dialogue box.

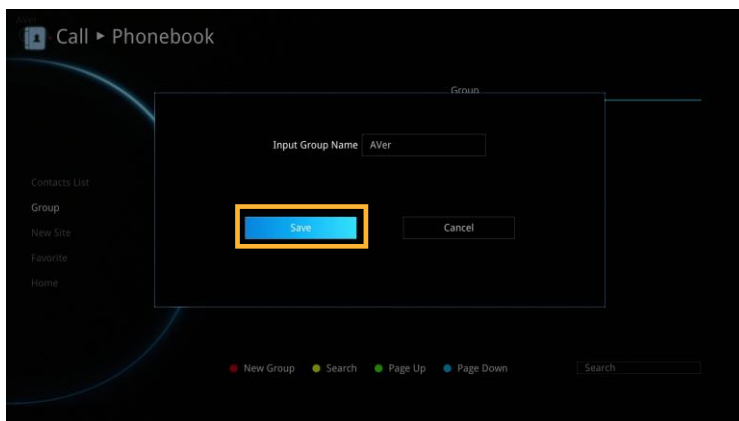

The new group name will be saved and displayed in the group list.

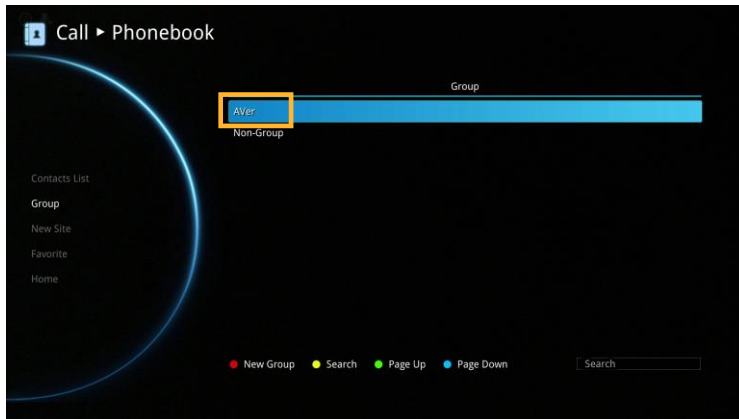

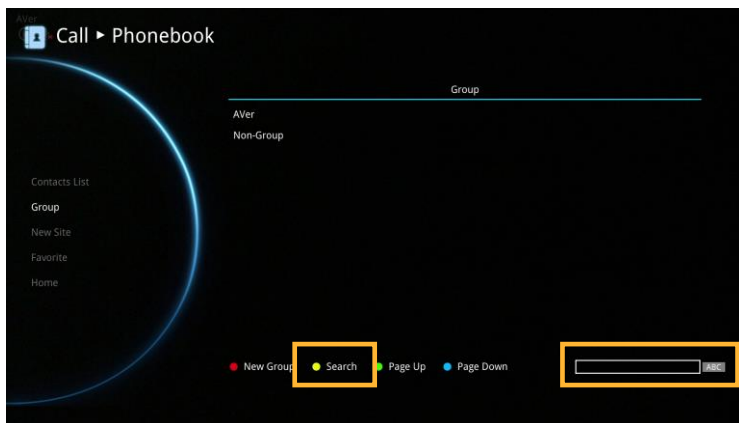

Search a Created Group

Press **“Yellow”**  button on the remote controller and enter the group name that you want to search.

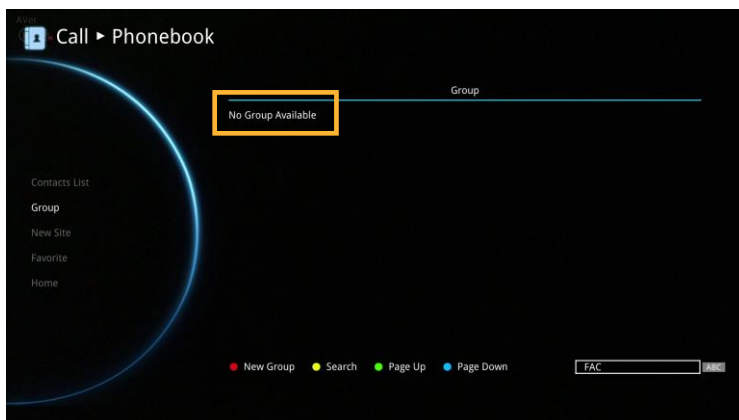

If the name you enter has not been created, the system will show you **“No Group Available”**, please search again.



If the Group data are over one page, you can also press **“Green”**  button or **“Blue”**  button to Page Up or Page Down.

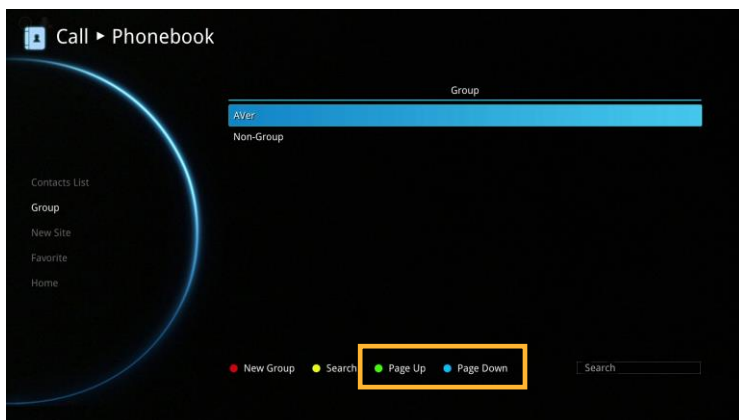

Edit Group

Select **Phonebook | Group** and press .

Select the name you want to modify in the group list.

Select **“Edit Group”** and press .

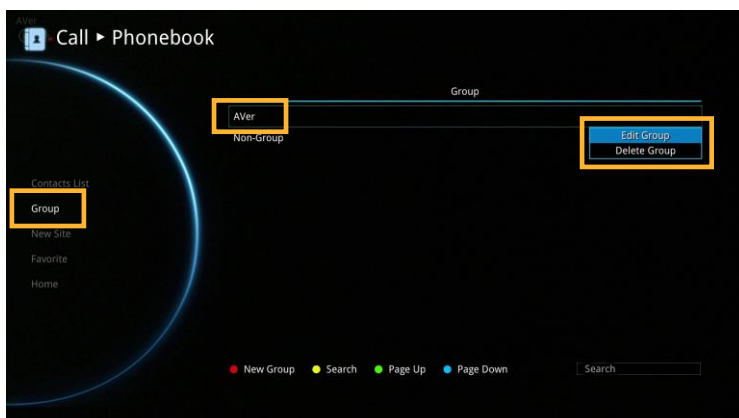

Modify the group name and select **“Save”** to save the revised group name.



The revised group name will be saved and displayed in the group list.

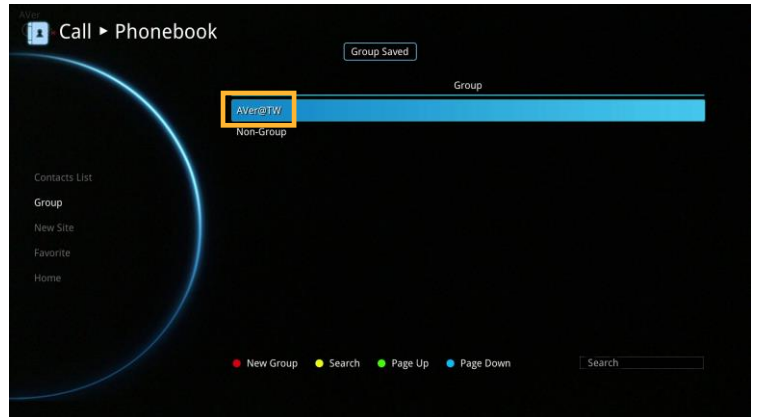

☞ If the revised name is the same as the saved name, the revised name will be ignored.

Add Contact from Group List

Select **Phonebook | Group** and press .

Select the Group name you want to add to Contacts List.

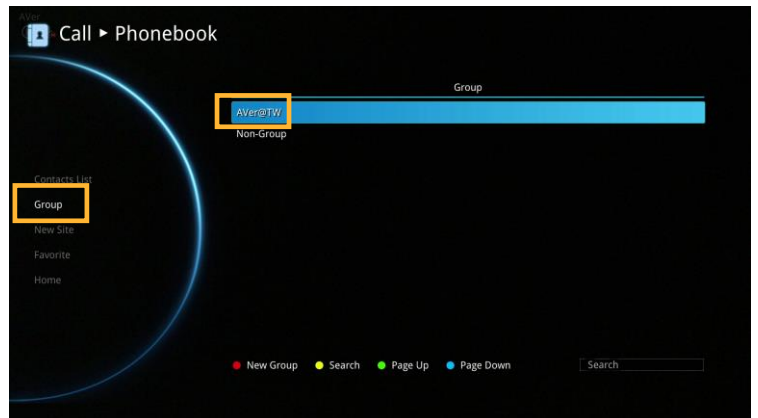

Select **“Edit Group”** and press .

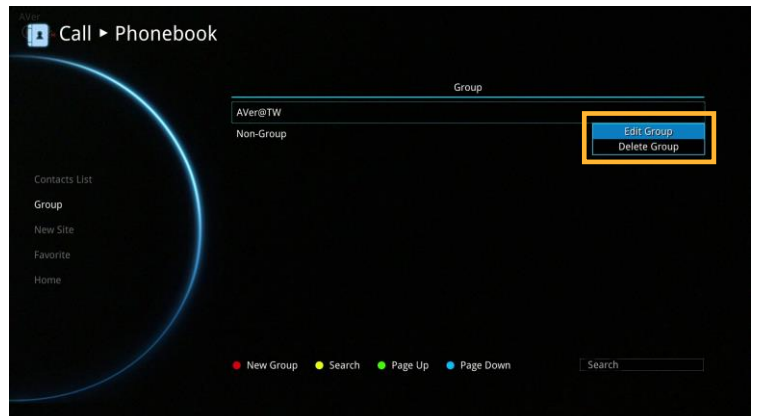

Confirm the Group Name what you want to add to the contacts list and then select **“Contacts List”**.



In the Group Site list, select the item that you want to add to the contracts list and then press **“Red”** button on the remote controller to save the selection.

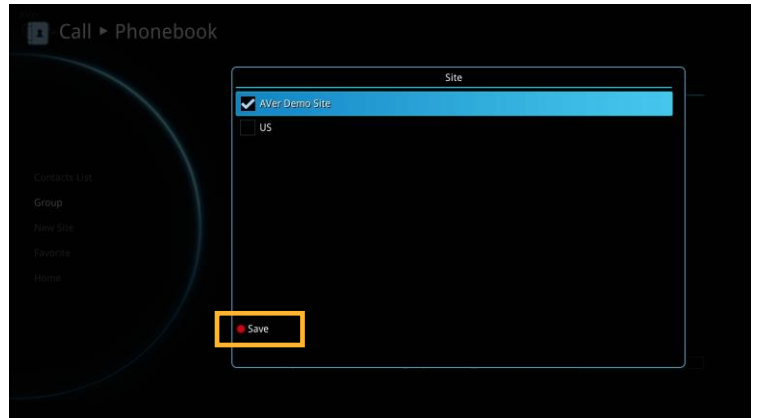

Select **“Save”** to save the Group name and added site to the contacts list.

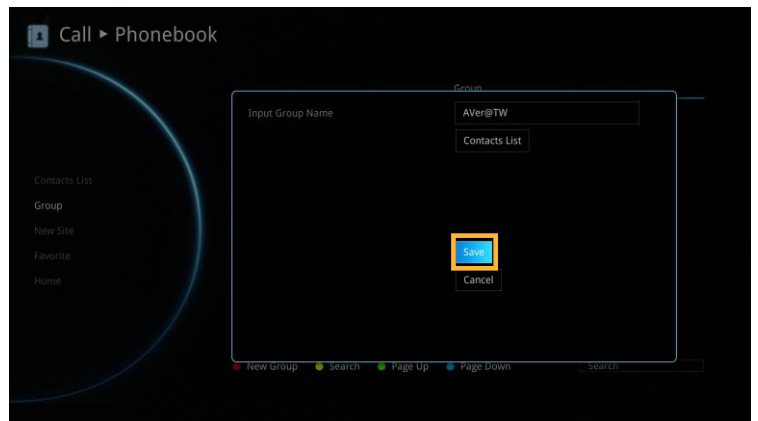

The selected Group name and added site will be added into the contacts list.



Delete Group

Select **Phonebook** | **Group** and press .

Select the name you want to remove in the group list.

Select **“Delete Group”** and press .

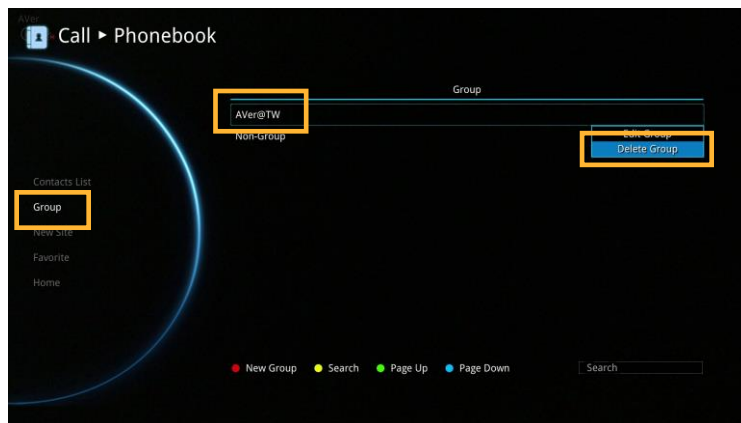

Select **“Yes”** to remove the selected group name and **“Cancel”** to cancel group name deletion.

The selected group name will disappear in the group list when deleted.

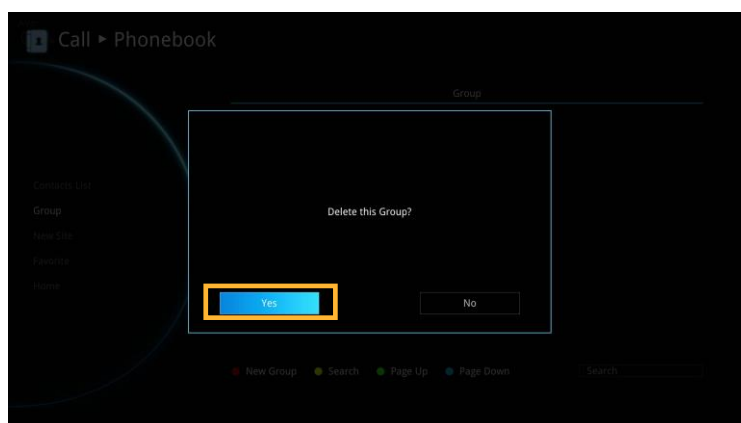

New Site (Contact in Phonebook)

New Site allows you to create and edit the information to each site.

Add New Site

Select **Phonebook** | **New Site** and press .

Select the **Group** name, if you don't want to add the entry into a group, please select **“Non-Group”** item.

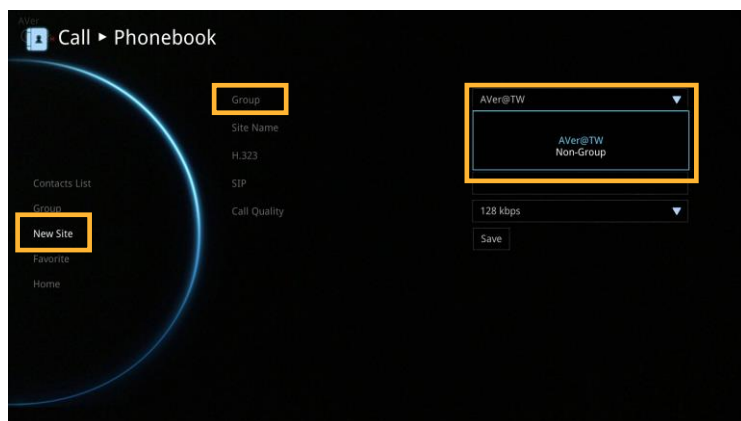

Select **Site Name** box. Enter the site name with the remote controller and press .

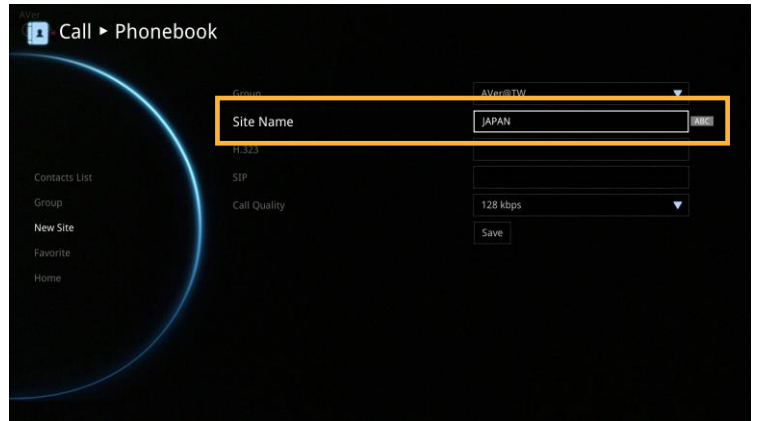

Enter the used call type information either H.323 or SIP.

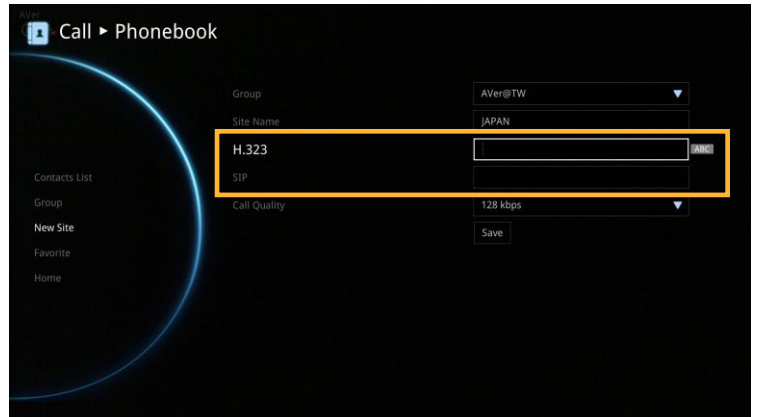

Select the desired call quality value in the drop-down list.

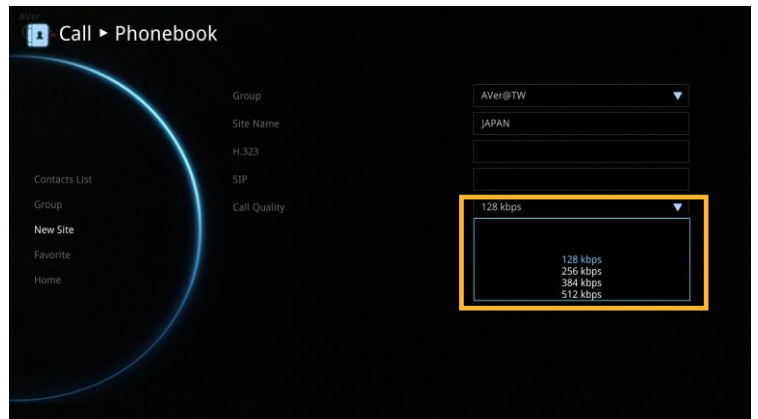

Select **“Save”** to store the newly added site contact.

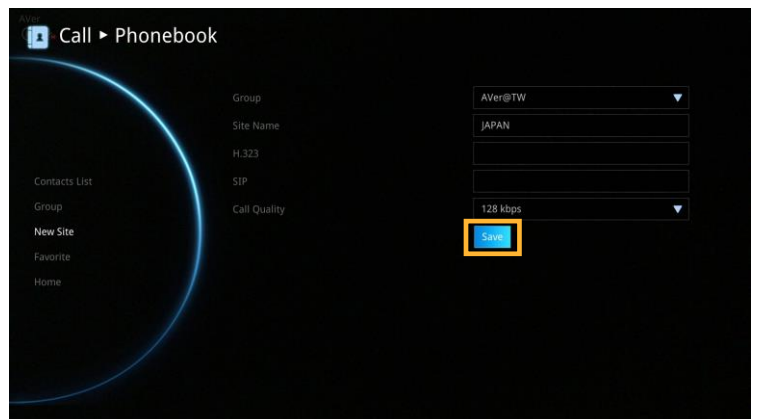

Edit New Site

Select Phonebook | Contacts List and press



Select the contact you want to modify and press



Select **“Edit Site”** and press

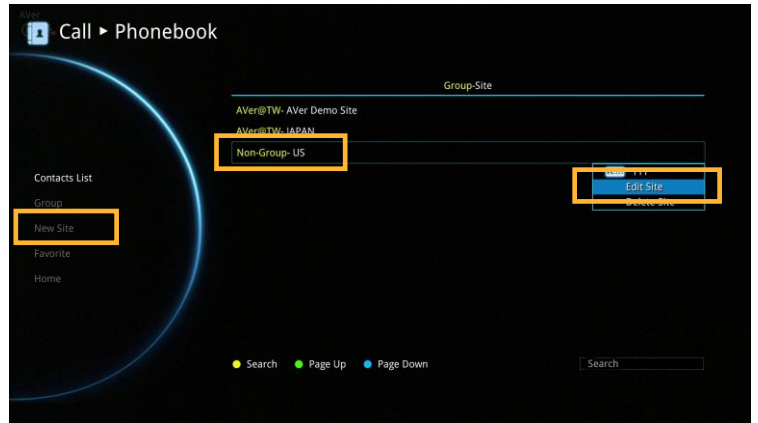

In the Edit Site screen, you may change the Group name, Site Name, H.323, SIP and Call Quality.

After making the changes, select **“Save”** to apply the new changes or **“Cancel”** to reserve the original settings.

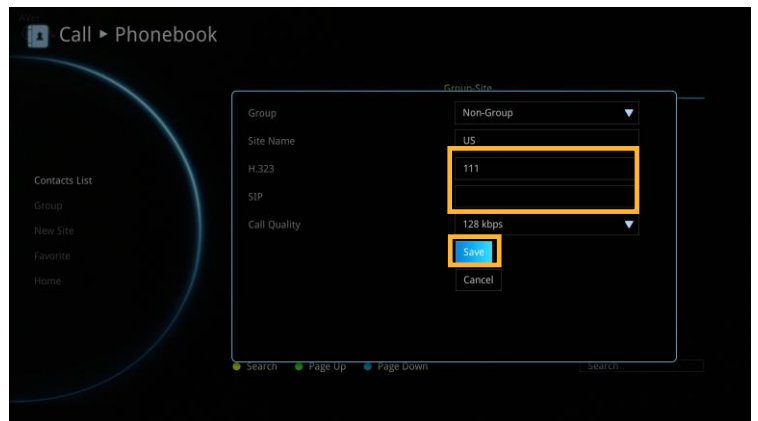

The saved changes will be shown in the Group Site list.

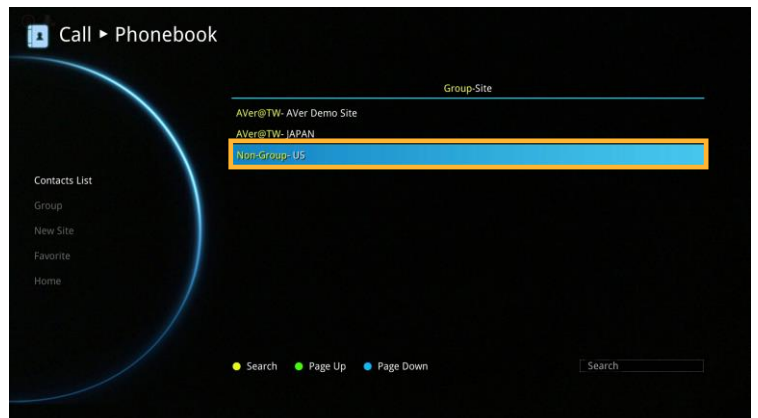

Delete New Site

Select Phonebook | Contacts List and press



Select the contact you want to delete and press



Select **“Delete Site”** and press

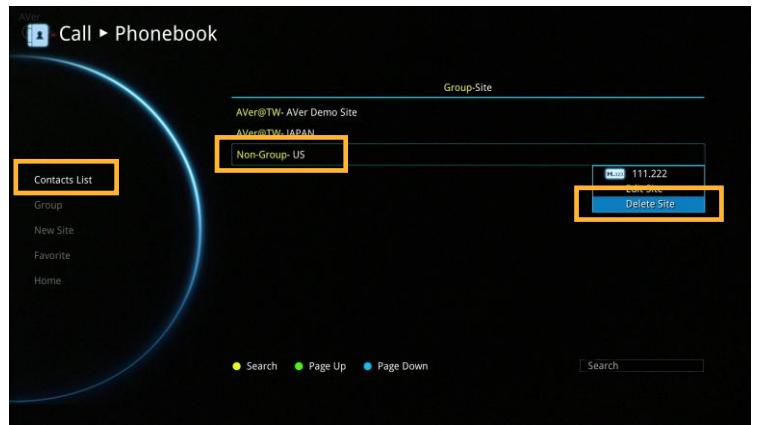

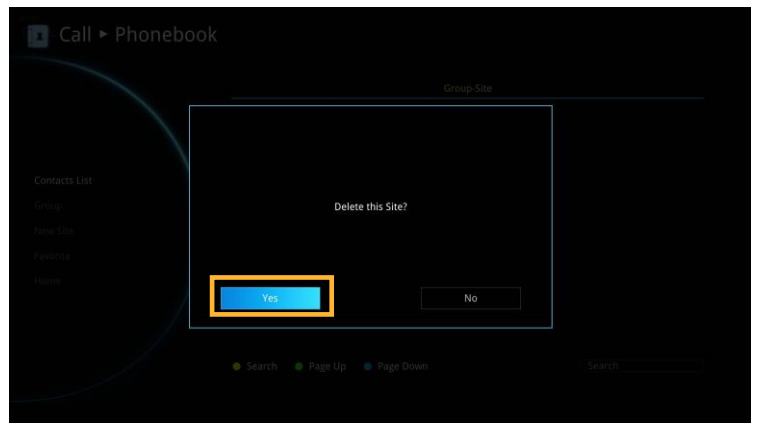

Select **“Yes”** to remove the selected contact and **“No”** to cancel contact deletion.

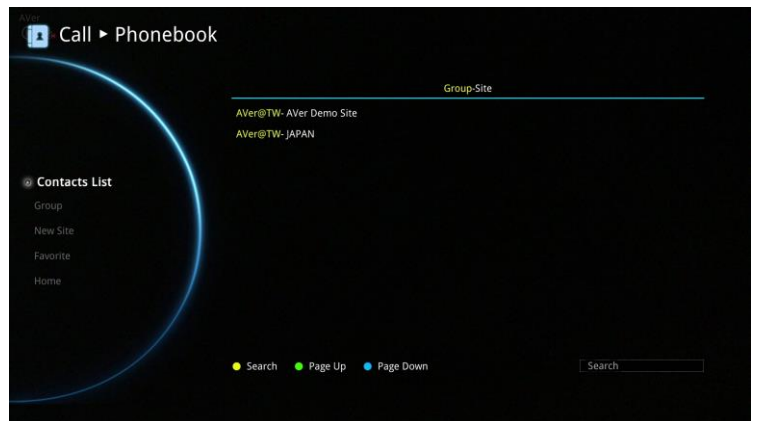

The selected contact will disappear in the Group-Site list when deleted.



Contacts List

Contacts List shows you all of the contacts that you have created and saved. You can select the contact from the **Contacts List** directly for modifying or deleting. In the Contacts List configuration screen, you can also use the “**Yellow**”  button on the remote controller to search the contact that you want. If the Group-Site over one page, you can also press “**Green**”  button or “**Blue**”  button to Page Up or Page Down.





Favorite

AVer EVC allows you save up to 10 most used contacts in the favorite list.

Select **Phonebook | Favorite** and press .

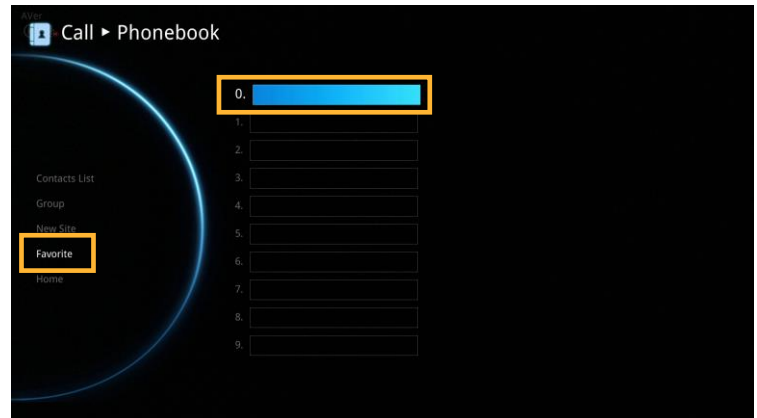
Select which line (0~9) do you want to save the favorite contact and press .



Select the contact from the pop-up **Group Site** list and press “**Red**”  button on the remote controller to save the selection.

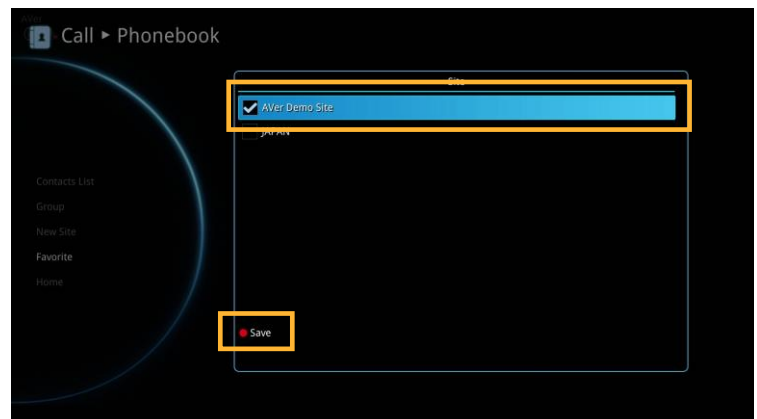

The item selected will be added into favorite list.

You can make the calls from the favorite list # (0~9) which you have set the favorite list, to press and hold the button # (0~9) via remote controller in Home menu screen.

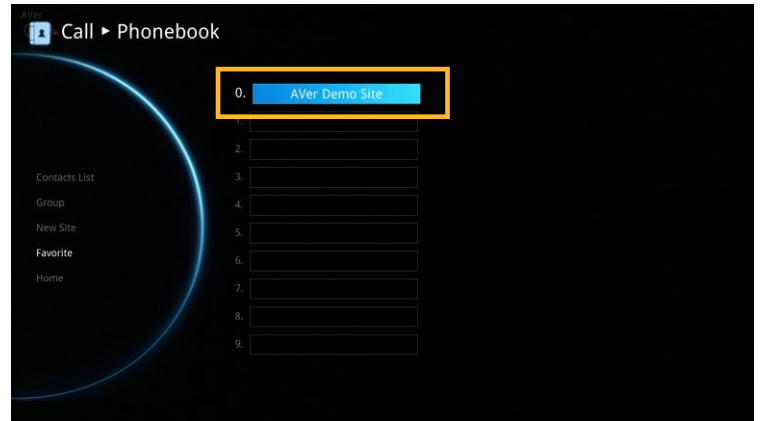

Call History





The Call History allows you to check the incoming/outgoing calls made and their status. You can also make a call by selecting it in the Call History list.



Call Status

Select **Call History** and press .



The Call History will show you the IP address or the Site name with call type, Call Date/Time and Call status. Refer to the table below to check the call status.

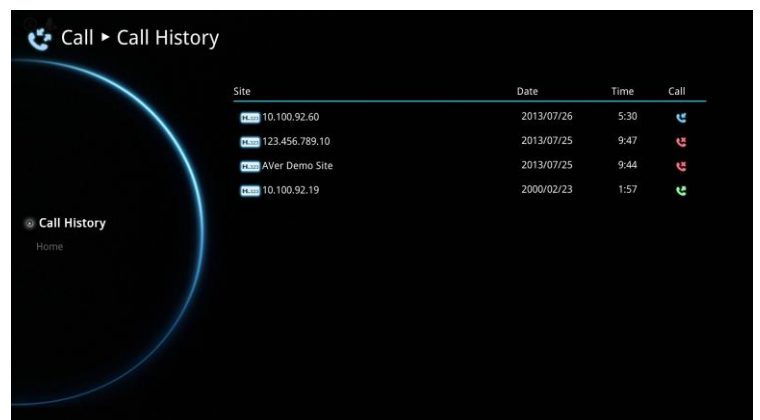

Call Status	Answered	Failed
IN		
OUT		



Make a Call From the Call History

Select **Call History** and press .

Use the  and  buttons to move the selection and scroll up and down in the call history list.

Press  and select **“Call”** to make a call.
Or press  button on the remote controller to make a call.

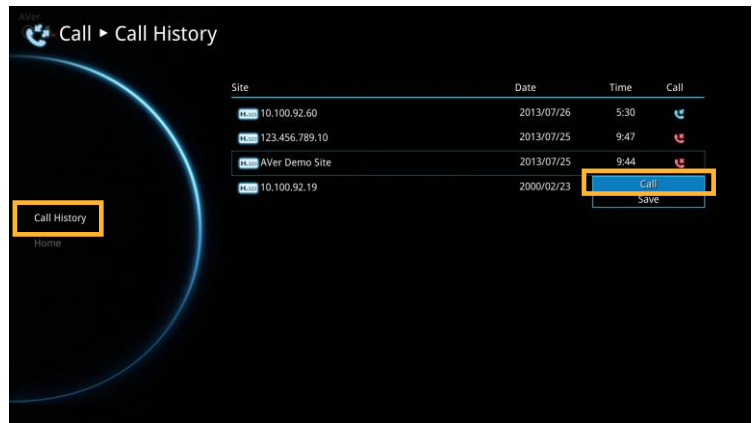

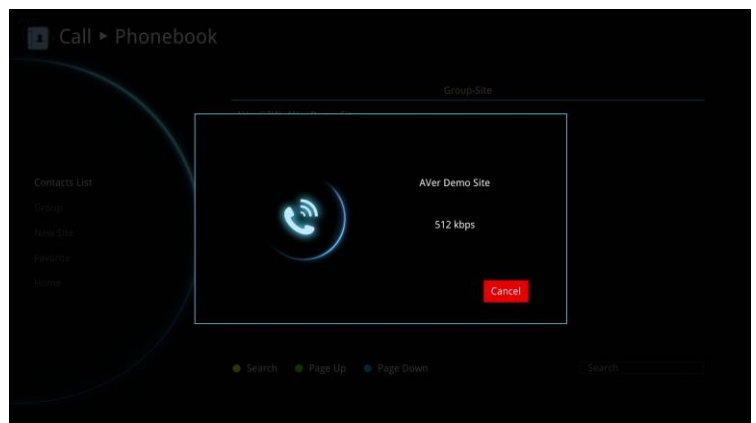

The call will be connected.



Make a Contact from the Call History

You can also save the call in/out information into your contacts list.

Select **Call History** and press .

Use the  and  buttons to move the selection and scroll up and down in the call history list.

Press  and select **“Save”** to pop-up contact editing form. All relative information has filled in the contact form already based on the selected call entry from the Call History.

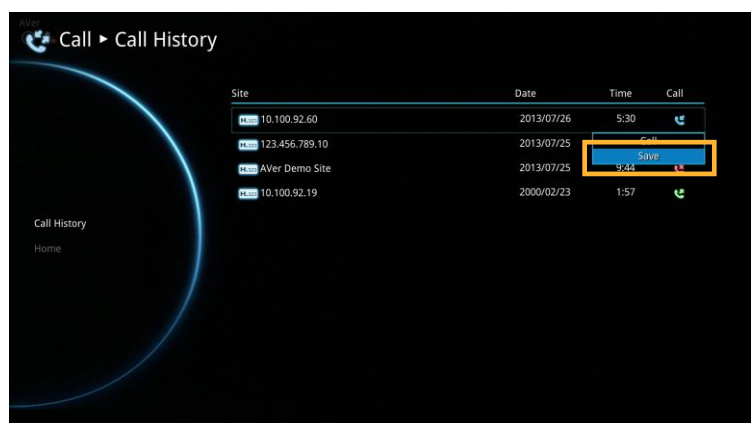

Confirm the **Group** selection then select **“Save”** to save the call entry into your contact.



General Setting

The General Setting allows you to modify system setting, authority of administrator, monitor setting, and adjust date and time.



Call Settings

Call Setting set the system to enable/disable auto answer, set the default call quality, and enable/disable Advanced Encryption Standard which ciphers the data to protect against unauthorized data access.

Auto Answer

Select General Setting | Call Settings and press .

Select **Auto Answer** and press . In the Auto Answer drop-down list, select **“OFF”** to turn off Auto Answer. **“ON”** to answer the call automatically and **“First Call Only”** to automatically answer the first call and answer or reject other incoming calls manually. If you are already in a conference, even if the Auto Answer is turned on, you also need to accept the next call manually.

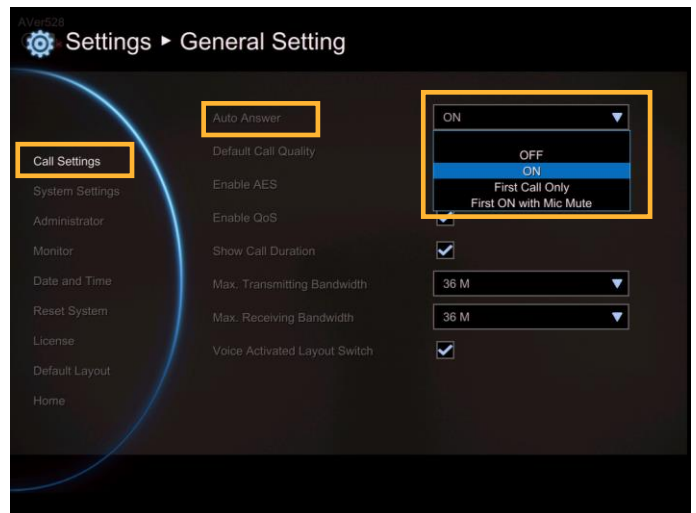

Default Call Quality

EVC main system supports 64K,128k, 256k, 384k, 512k, 768k, 1024k, 1152k, 1472k, 1536k, 1920k, 2048k , 3072k, 4096k selection for default call quality. By default, it is set to 512k.

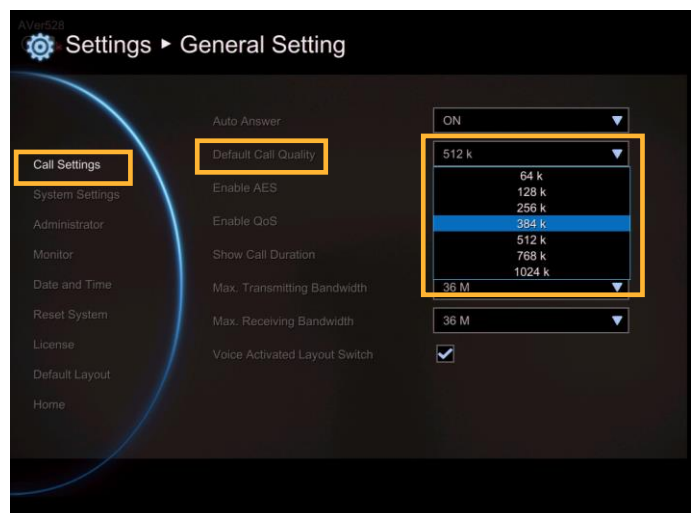

Enable/Disable AES

Advanced Encryption Standard (AES) encrypts the data that is being transmitted during a video conferencing to provide protection against unauthorized data access. Encrypted data can only be read with the device that also supports the AES standard. All parties on the call must support AES to use this feature, or else the data will not be encrypted.

Select **General Setting | Call Settings** and press . Select the **Enable AES** check box to active this function.

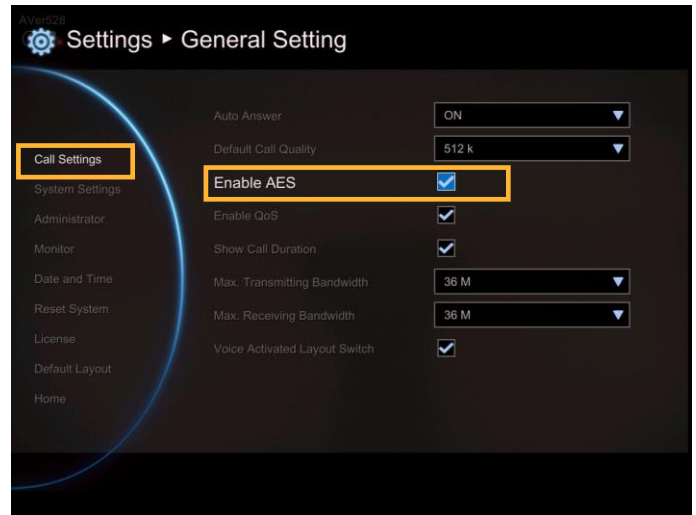

 This function may be restricted and unavailable in some countries.

Enable/Disable QoS

Quality of Service (QoS) provides different priority data flows to guarantee a certain level of performance in video conferencing data flow. To activate QoS, select **General Setting | Call Settings** and press . Select the **Enable QoS** check box to active this function. By default, this function is disabled.

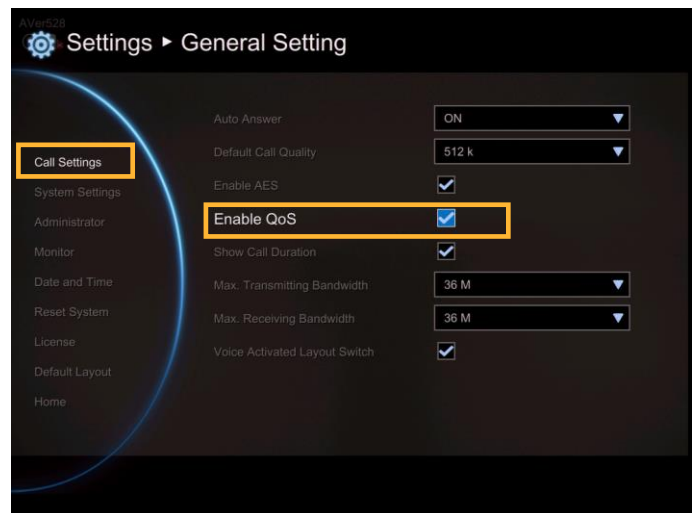

Show Call Duration

Enable/disable the call duration showing, by default, this function is enabled.

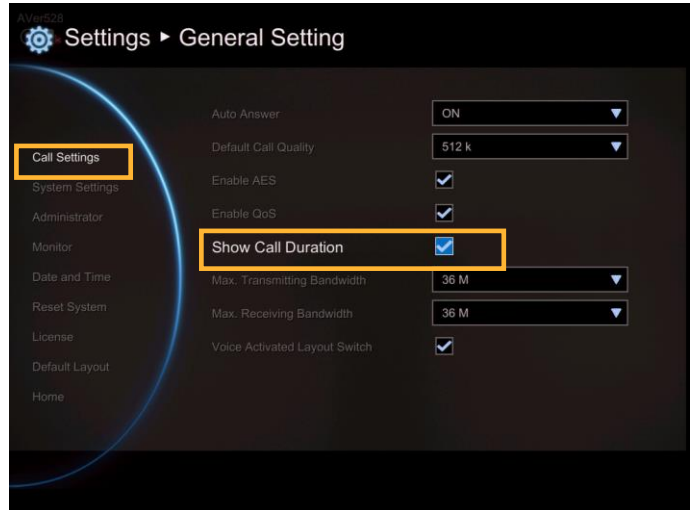

Max. Transmitting/Receiving Bandwidth

This function allows you to specify the maximum bandwidth of the outbound and inbound calls. AVer EVC system supports up to 36M.

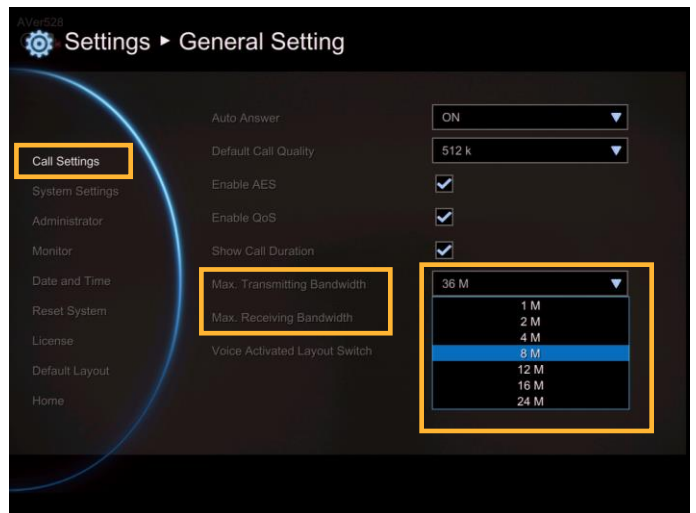

Voice Activated Layout Switch

During the video conferencing, the EVC system will detect which connected point is talking and show the video of talking point into enlarge screen view.

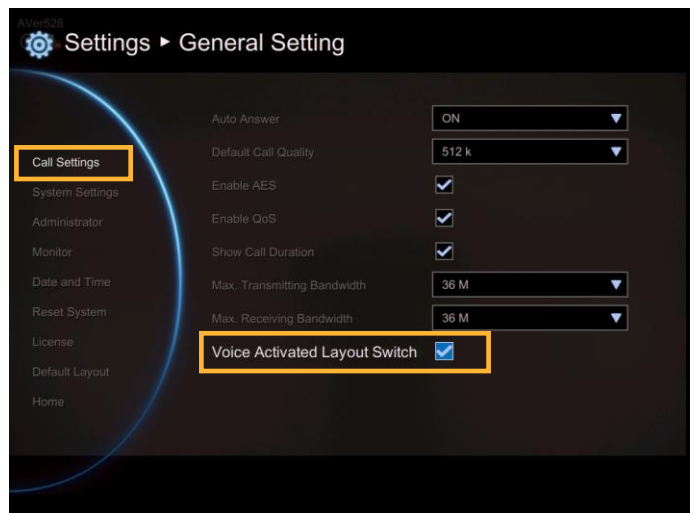

[Note]

1. When function of Voice Activated Layout Switch is enabled, the multiple connections must over 3 points.

2. When voice activate function is disabled, the screen is displayed the video of first connected call.
3. In Figure 1, the layout 2 ,3 and 4 are displayed the talking point at largest video screen area and rest of points are displayed in small video screen area. If connecting point doesn't enable "Voice Activated Layout Switch" function, it will display in small screen.
4. In Figure 1, the layout 4 is displayed talking point on largest video screen area. If Voice Activated Layout Switch doesn't enable, the largest video screen area is displayed video of local site.

For example:

Layout Sites	1	2	3	4	5	6
3						

Figure 1

System Settings

System Settings allows you to enter or change your system's site name which will appear on the screen during the call session for the other party to identify you, set Language, the time for Auto Power off and enable/disable Keypad Tone function for your main system.

Site Name

Select General Setting | System Settings and press . The site name is represented as name of this EVC system. Enter the site name as you wanted.

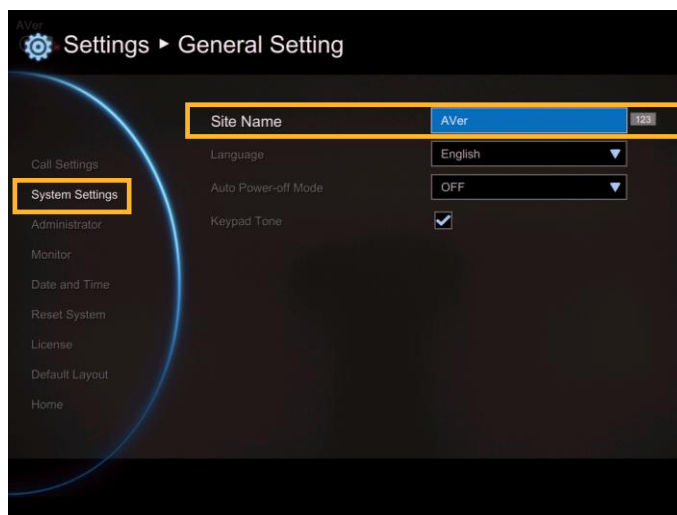

Language

Select General Setting | System Settings and press .

EVC main system supports up to 21 languages for your selection. Select the language from the drop-down list directly and the language for the system will turn into the selected language automatically.

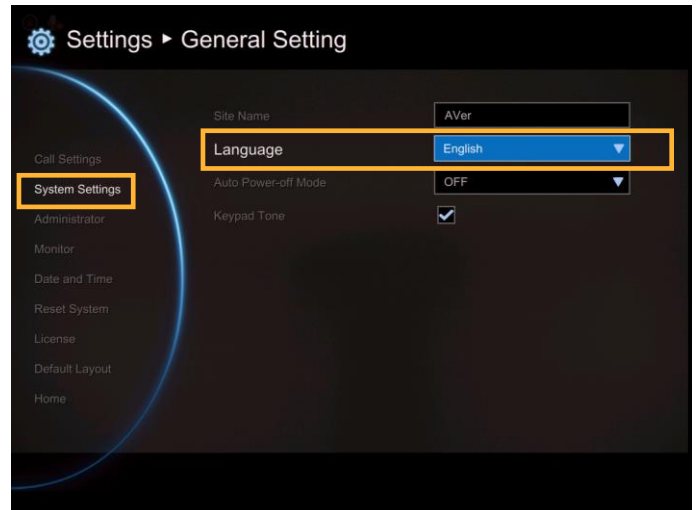

Auto Power Off Mode

Auto Power Off Mode allows you to set the time to power off your system automatically after idling.

Select General Setting | System Settings and press .

Select the time from the **Auto Power Off Mode** drop-down list (OFF/30Minutes/1Hour/2Hours/3Hours/4Hours). Disable this function, please select “**OFF**”. The function will completely turn off the system once you have set the auto power off time. To turn on the system you need to press the Power button on the EVC main unit again.

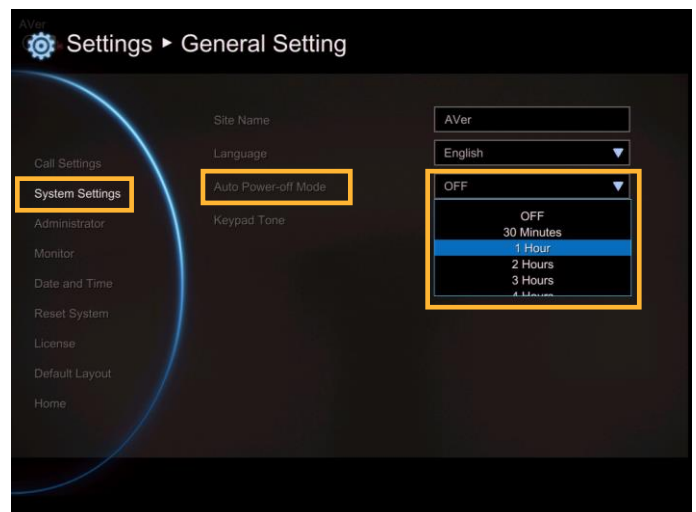

Keypad Tone

Keypad Tone allows you to enable/disable tone sounds when you are dialing a number using the remote controller.

Select General Setting | System Settings and press .

Select the Keypad Tone check box to enable the tone sounds. By default, this function is enabled.

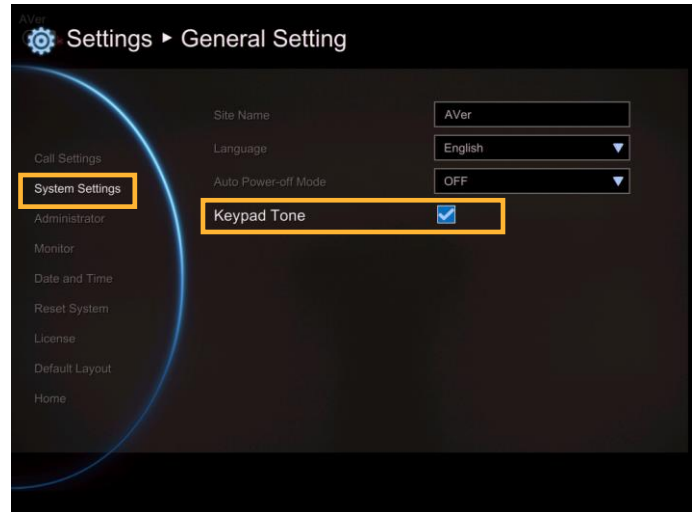

Administrator

Enable Web Admin

Select General Setting | Administrator and press .

Here allows you to enable administrator authority of Web Tool. When you access to Web Tool, a password is required. The default password is "1234".

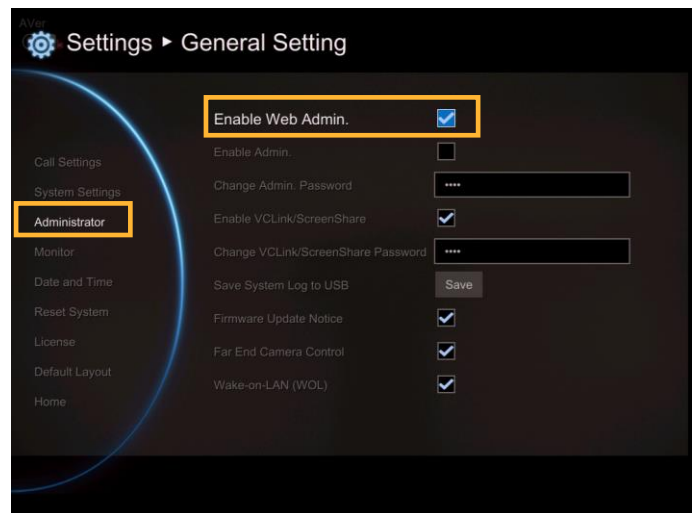

Enable Admin

Select General Setting | Administrator and press .

Here allows you to enable authority of system administrator. When you want to setup system, a password is required. The default password is "1234".

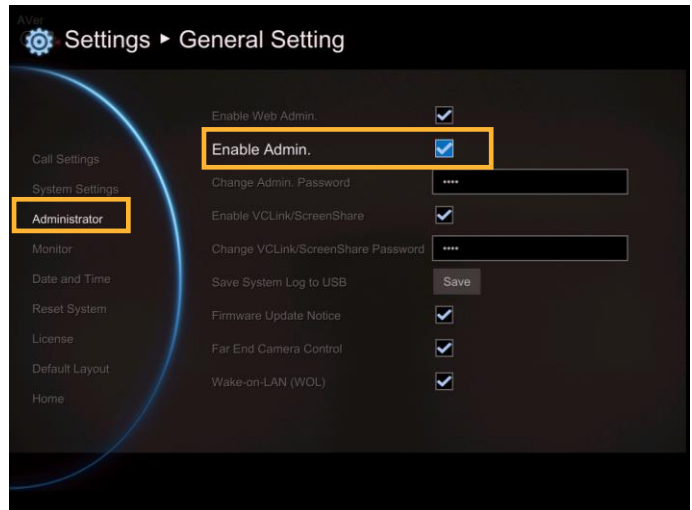

Change Admin. Password

Select General Setting | Administrator and press .

Here allows you to change password of system administrator.

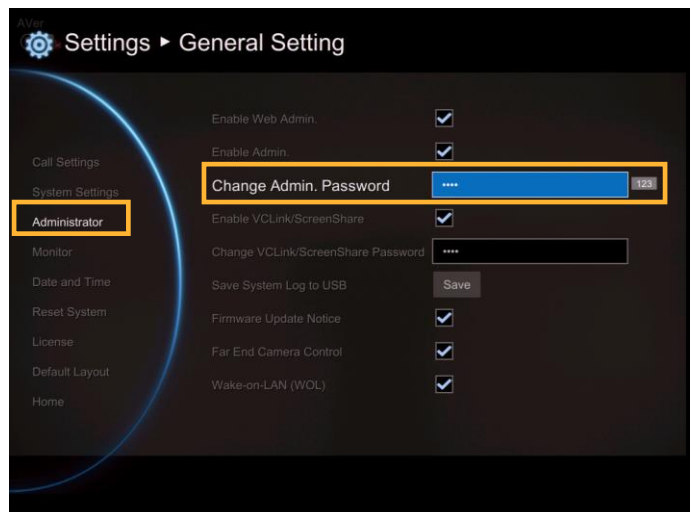

Enable VCLine/ScreenShare

Select General Setting | Administrator and press .

Here allows you to enable function of VCLink and ScreenShare.

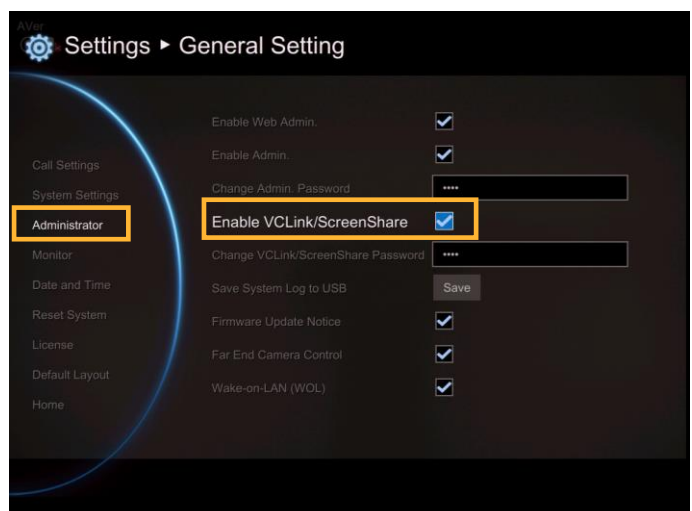

Change VCLink/ScreenShare Password

Select General Setting | Administrator and press .

Here allows you to change password of VCLink and ScreenShare. The default password is "1234"

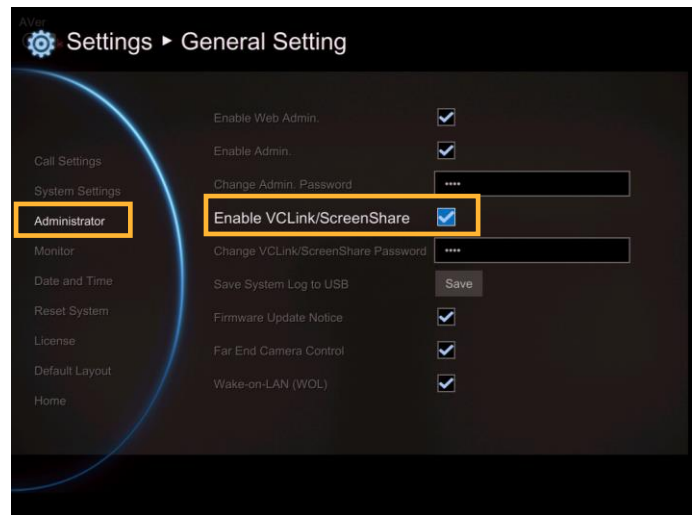

Save System Log

If you encounter unknown issues and are unsure of how to troubleshoot the unit, sending us the saved system log data to help us solve your problem faster.

Insert a USB Flash drive into the USB Port(on front panel)) of the EVC main system.

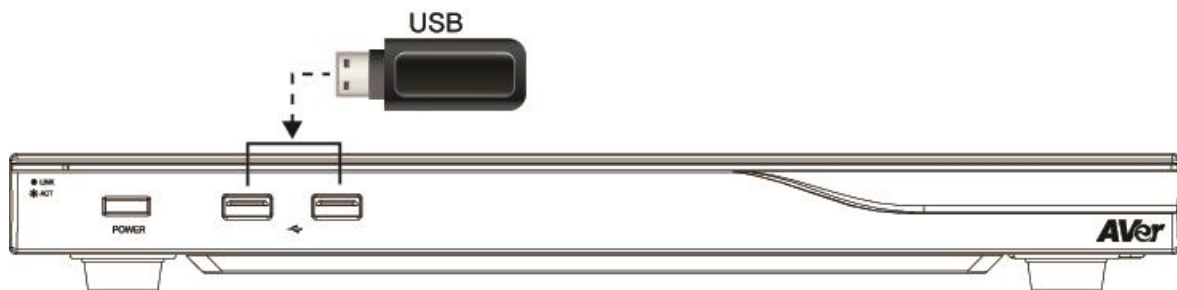

Select **"Save"** located next to **"Save System Log"** to save the system log into your USB Flash drive.

After the file is saved, select **"OK"**. Remove the USB Flash drive and insert it into your computer's USB port. Located the file message.tar.gz and send it to the technical support team.

 message.tar.gz

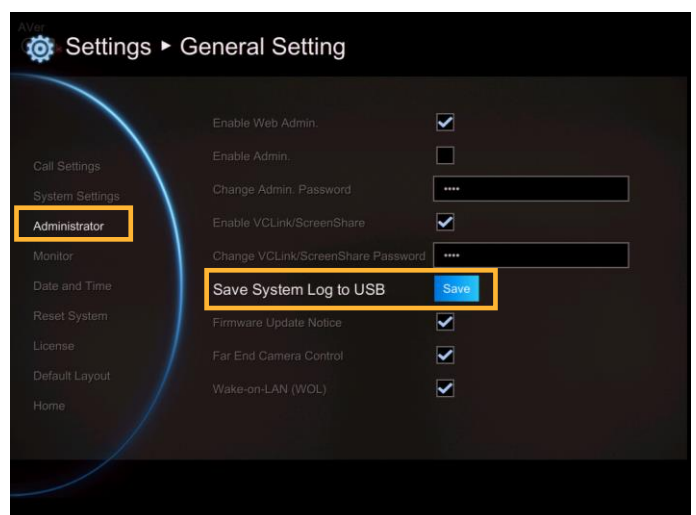

Firmware Update Notice

Select this function check box to enable firmware updated notice function. By default, this function is enabled.

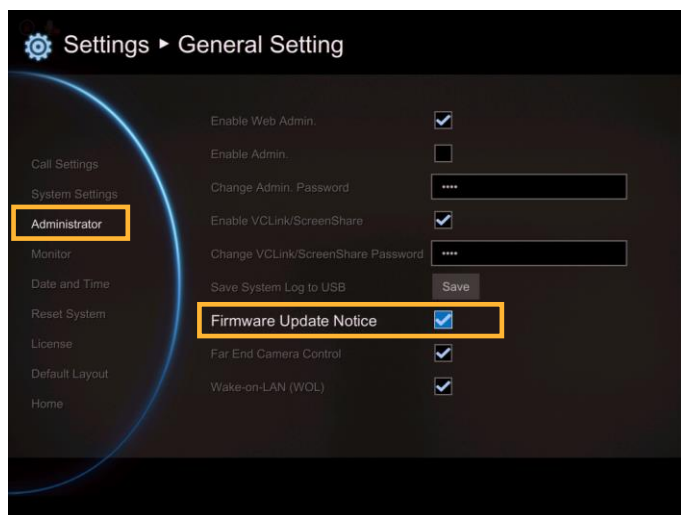

Far End Camera Control

Select the “Far End Camera Control” check box to enable the far site to control your camera. By default, this function is enabled.

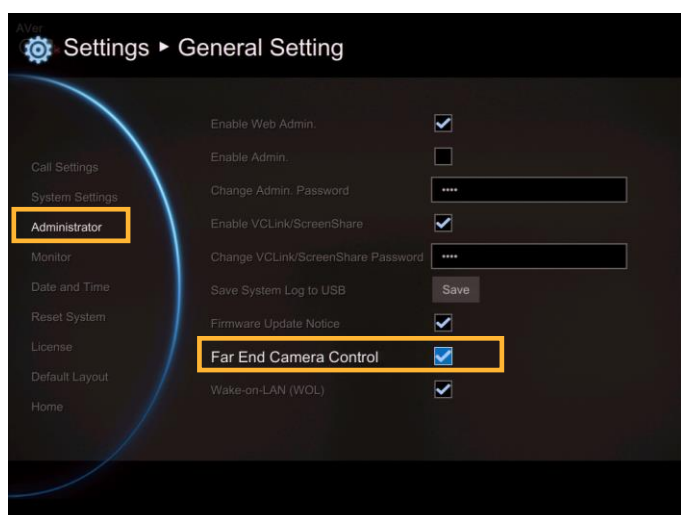

Wake-On-LAN (WOL)

Wake-on-LAN is an Ethernet computer networking standard that allows your computer to be turned on or awakened by a network message. By default, this function is disabled.

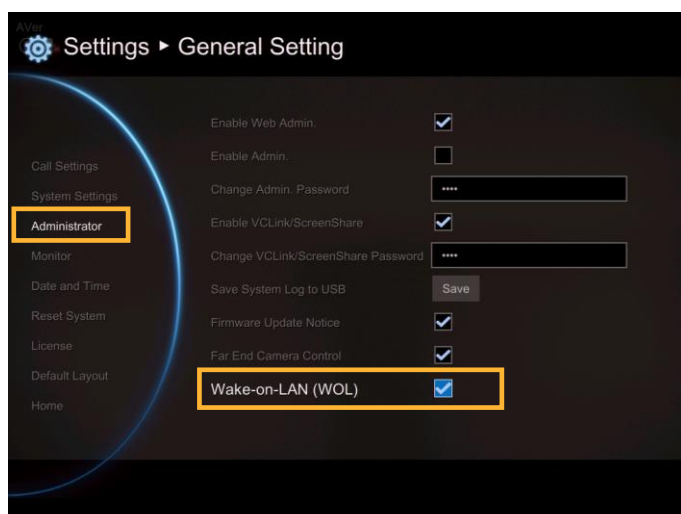

Monitor

EVC main system allows you to connect dual monitor. In the **Monitor** configuration screen, you can configure the **Aspect Ratio** and **Screen Saver** to each monitor.

Select General Setting | Monitor and press

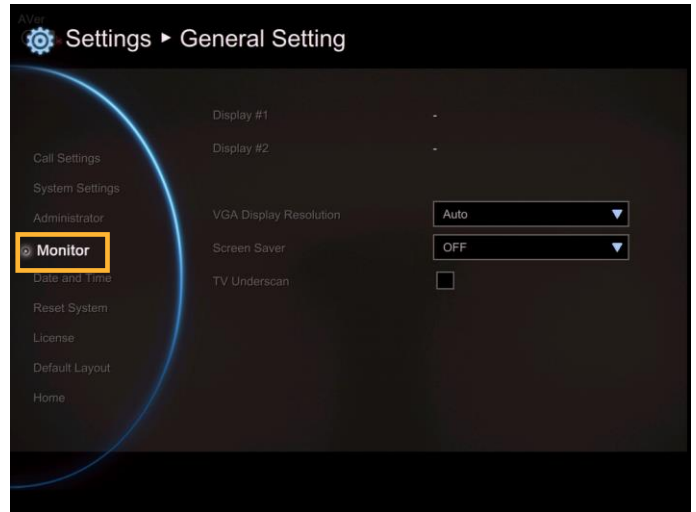

Select the Monitor Aspect Ratio (Auto /4:3/16:9) that you want from the drop-down list and press . If you want the system to detect the right setting automatically, please select **“Auto”**.

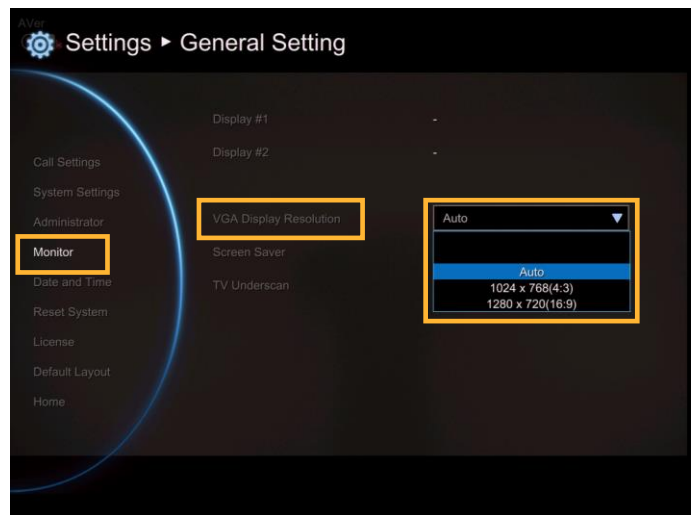

Select the Screen Saver time (OFF/10 Minutes/20Minutes/30Minutes/60Minutes) from the drop-down list and press . You can select **“OFF”** to disable this function or define a standby mode time.

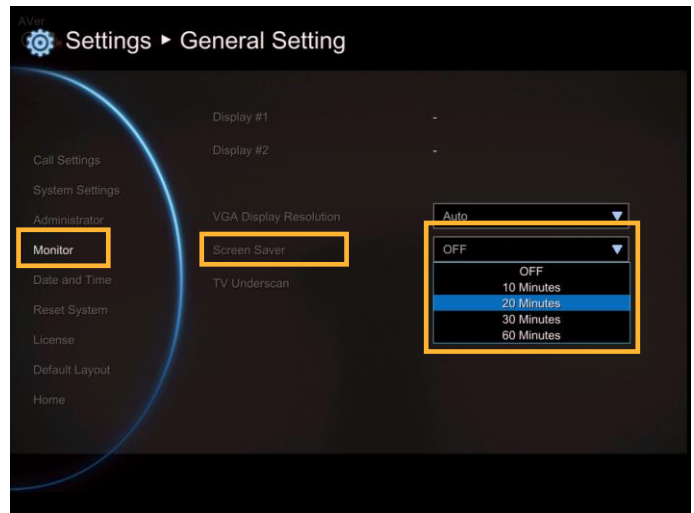

The screen will turn black when the system is in standby mode. Press any button on the remote controller to wake up the system.

TV Underscan

For older type TVs/CRT monitors, this function can help to auto adjust screen view when the GUI is exceeded the monitor view range.

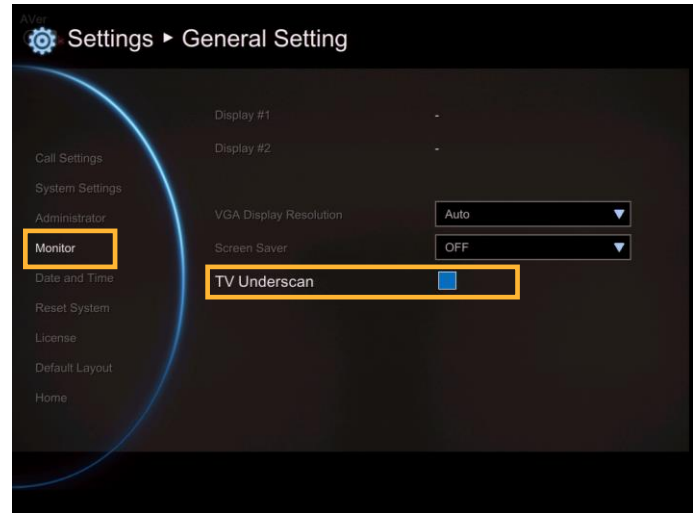

Date and Time

Date and Time allows you to set the Date and Time formats, adjust the time setting and change the time zones around the world and countries.

Date Format

Select General Setting | Date and Time and press .

Select the Date Format (yyyy-mm-dd/mm-dd-yyyy/dd-mm-yyyy) you prefer from the drop-down list.

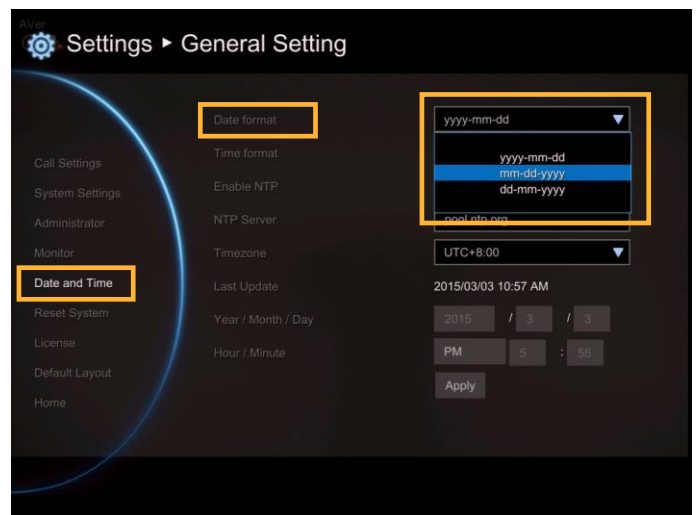

Time Format

Select General Setting | Date and Time and press .

Select the Time Format (24-hour/12-hour) you prefer from the drop-down list.

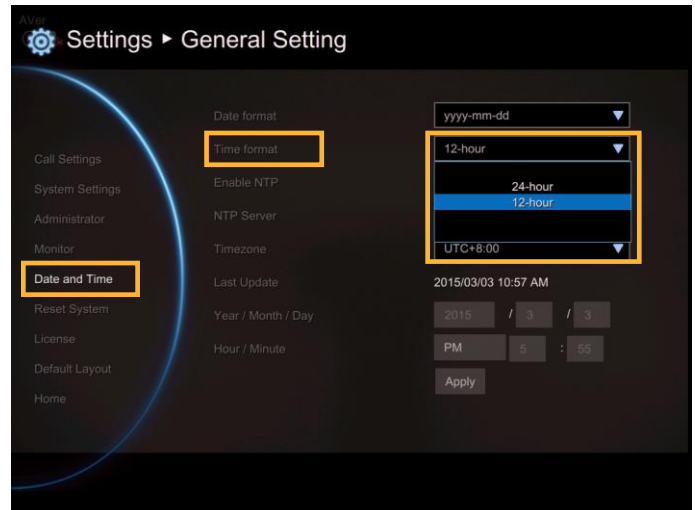

Enable NTP

Network Time Protocol (NTP) is a protocol that is used to synchronize computer clock times in a network of computers. Select the **Enable NTP** check box to make your main system time the same as the network time.

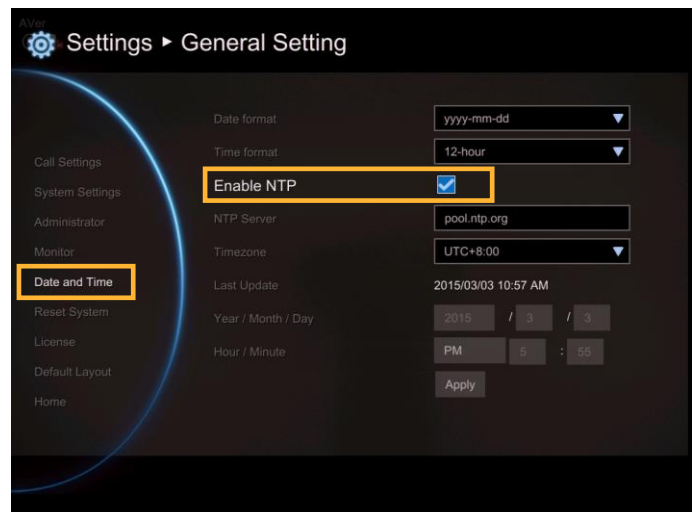

NTP Server

The Network Time Protocol (NTP) allows administrators to synchronize all network computers to a main server. This keeps all network machine clocks on the same time. Enter the NTP Server name that you want to follow.

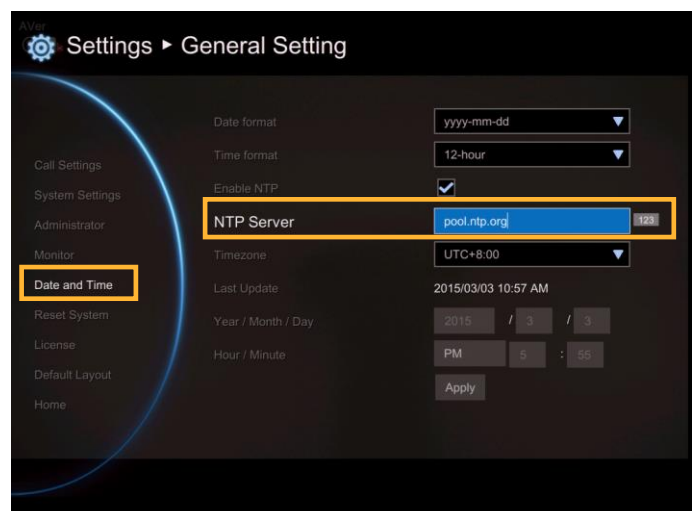

Timezone

Timezone allows you to adjust the time when you are in a different country or area so that you can keep the same time with your original area. Most of the time zones on land are offset from Coordinated Universal Time (UTC) by a whole number of hours (UTC-12 to UTC+14).

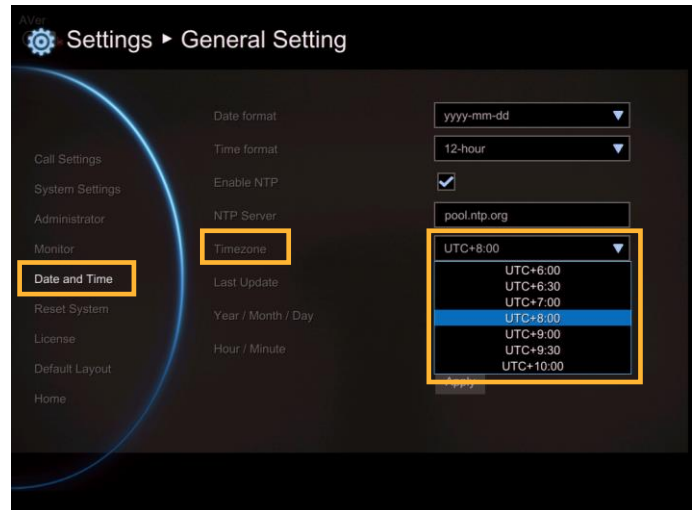

Year and Hour

Enter the date and time including year, month, day, hour and minute that you want to show on the present system.

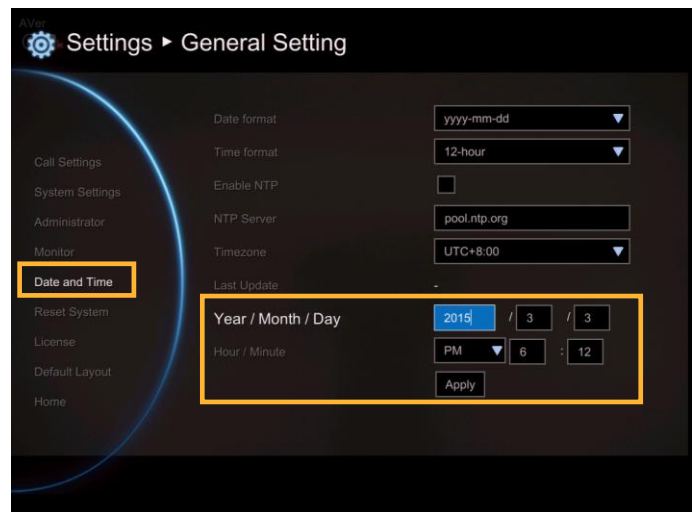

Select **“Apply”** to active your settings.

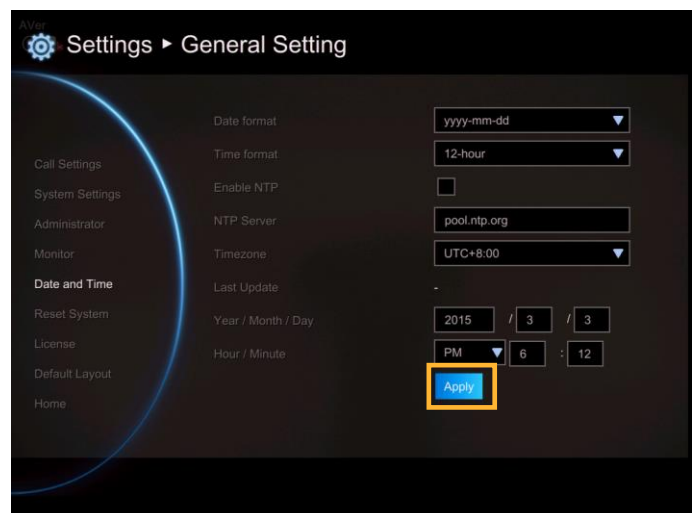

Reset System

The Reset System allows you to reset your main system to factory settings, which will clear phonebook entries and call history. Make sure to back up the information before resetting the system.

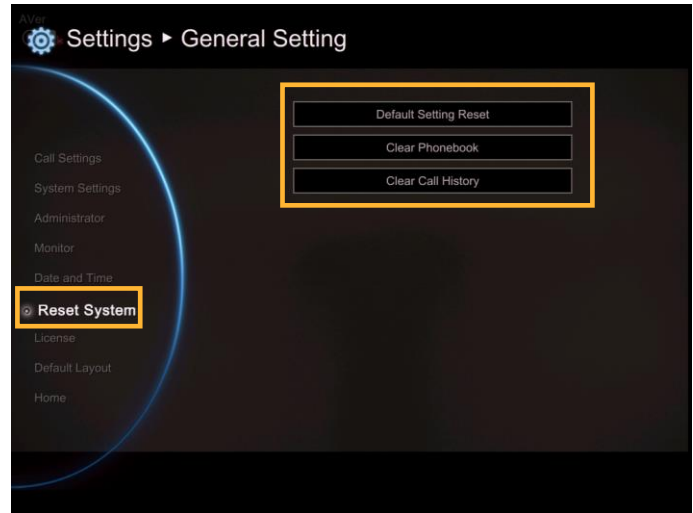

Default Setting Reset: LAN configuration, video/audio codec selection, call settings and so on will be reset. Click “Yes” to reset your system to factory default values.

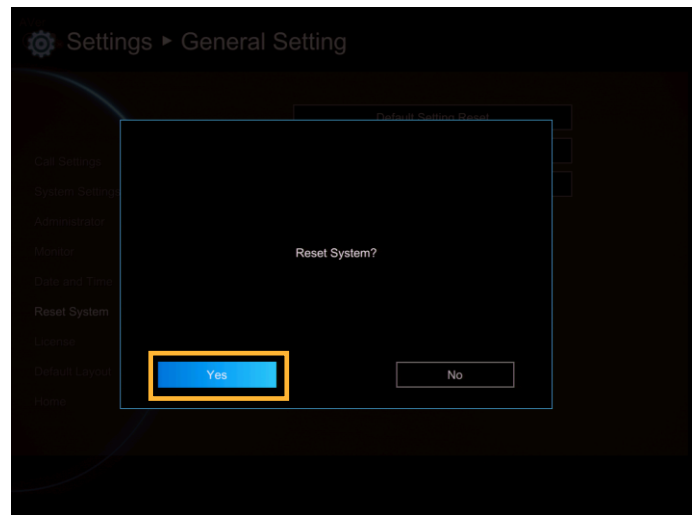

Clear Phonebook: All the phonebook entries saved in the system will be deleted.

Click “Yes” to delete all content of your phonebook.

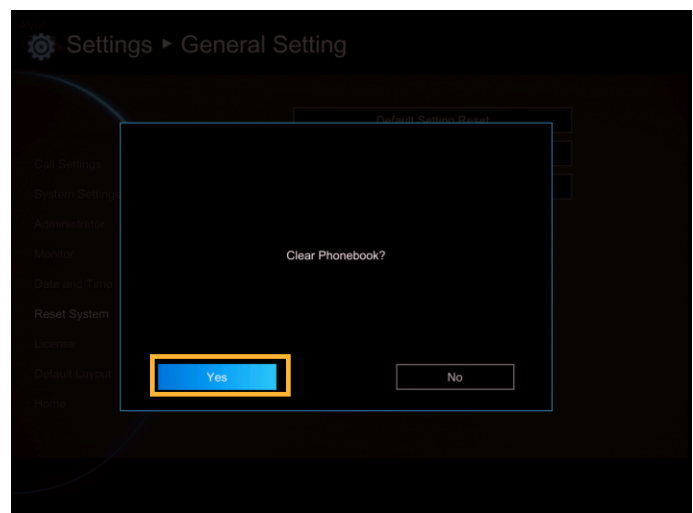

Clear Call History: All the incoming and outgoing call records will be deleted. Click “Yes” to delete all calling information of the call history.

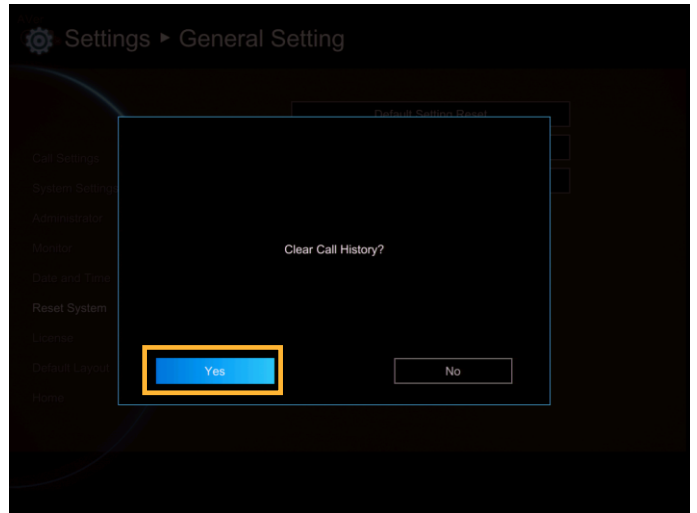

License

EVC300/EVC350 can purchase license to increase call-point up to 10 call-points. To purchase license, please contact your sales dealer.

[Note] EVC900/EVC950 is a 10 call-points device, the license purchase is not allowed.

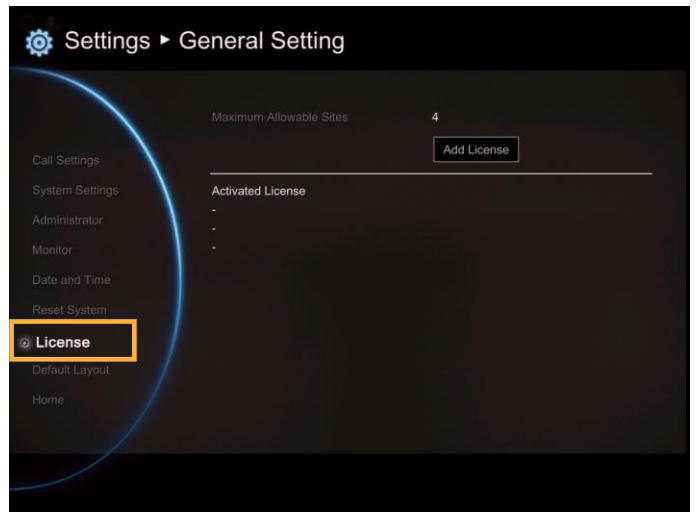

Select **Add License** to enter license serial number.

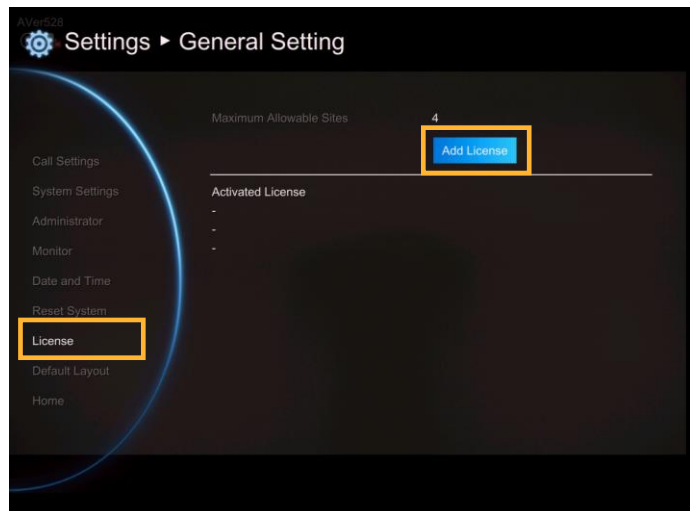

Press **keypad button** on remote and enter the license serial number. After entering, select **OK** to back to License enter page. Then, select **Activate** to register the license.

[Note]

1. License serial number is capital sensitive.
2. One license only for one EVC device.

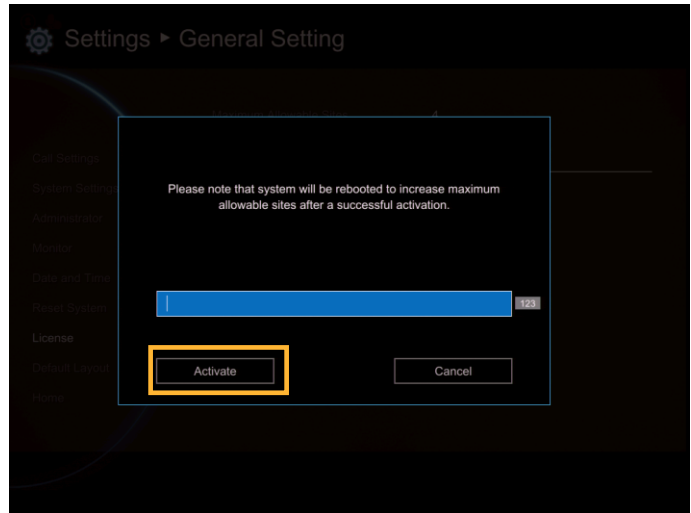

You will see the license serial number list in Activate License section.

To enter another license serial number, follow above steps.

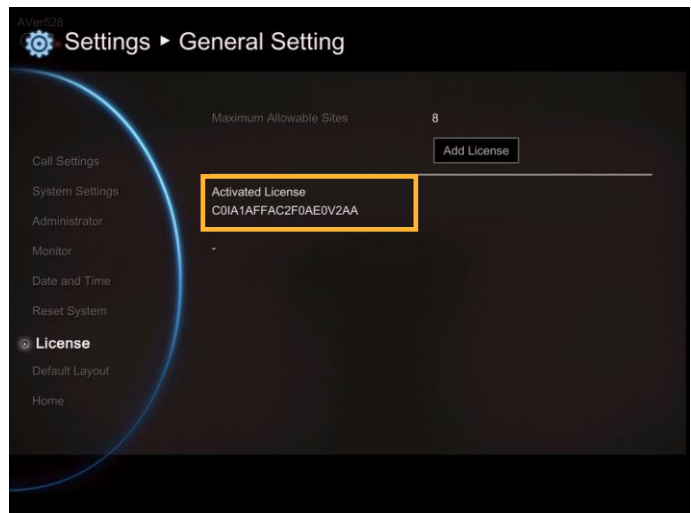

Default Layout

You can select the layout for call conference. There two type of layout – Layout without content and Layout with content.

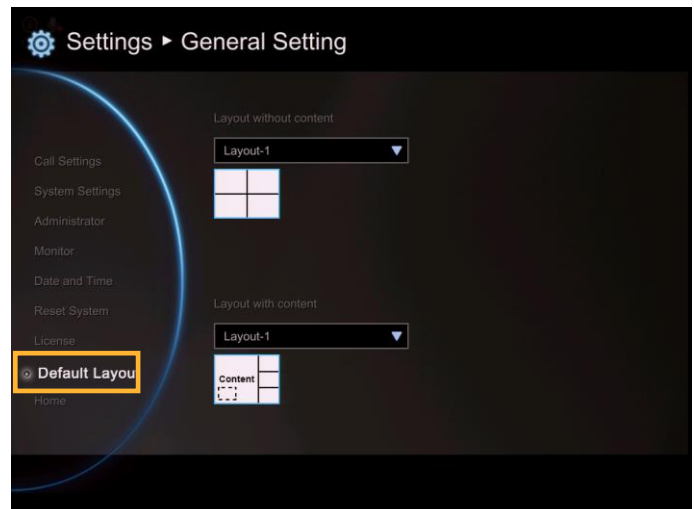

Layout without content: Only display call video, no content share screen.

There 4 layouts can be chosen. During the call conferencing, the display layout will be the layout that you has chosen.

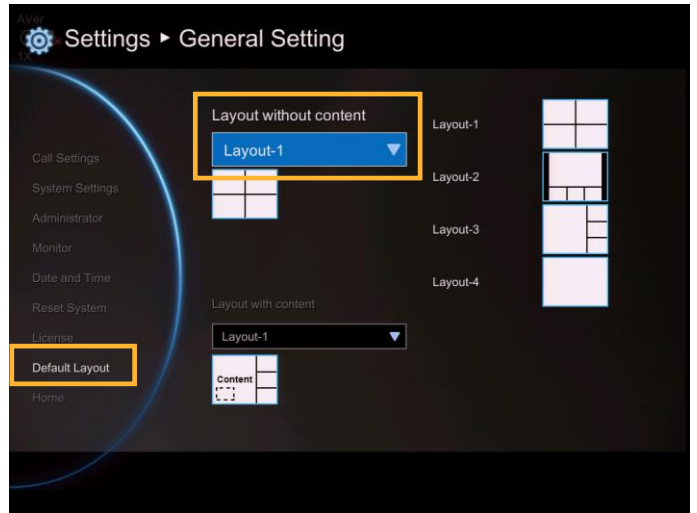

Layout with content: display call video and content share screen.

There 6 layouts can be chosen; but only 2 layouts include content share screen. During the call conferencing, the display layout will be the layout that you has chosen.

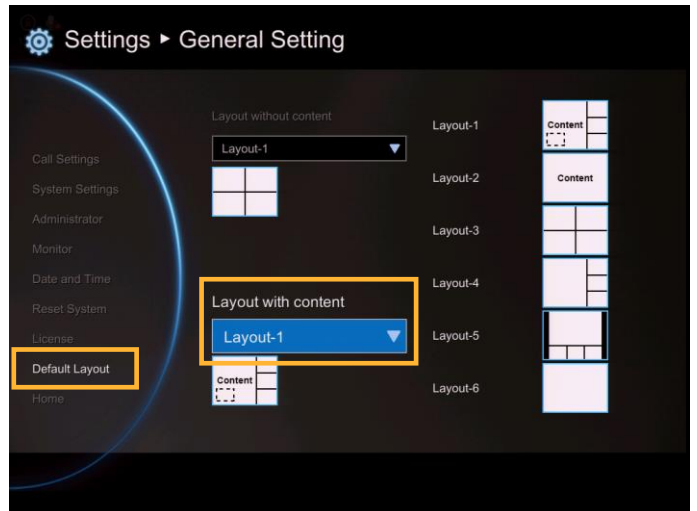

Video/Audio

In **Video/Audio** configuration screen, you can set the MIC gain level, select the preferred video and audio codecs and adjust the camera functions.



Camera

Camera allows you to set the **White Balance**, **Exposure**, **Sharpness**, and **Frequency** for your camera.

White Balance

Whit balance is a camera setting that adjusts for lighting in order to make white objects appear white in photos.

Select **Video/Audio | Camera** and press .

Select the **White Balance** type from the drop down list. EVC main system supports up to 5 types of white balance for your selection.

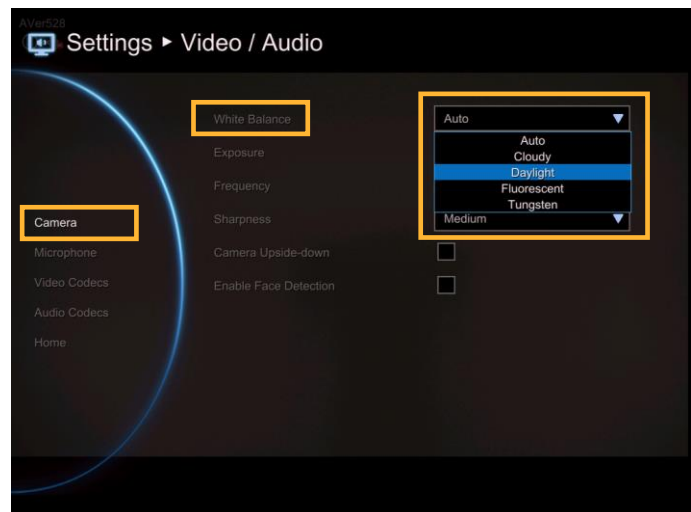

Auto: Most cameras default to automatic white balance. It makes white objects bright white and alter all the other colors to match.

Cloudy: You can use the **Cloudy** white balance setting instead of auto on a cloudy day. This allows the camera to compensate for blueness in the shadows, warming up the scene to better match what your eye would see.

Daylight: You can use **Daylight** settings only when shooting in very bright sunlight, as it can produce bluish results on overcast days.

Fluorescent: You can use **Fluorescent** setting to cancel out the green or blue cast, which can produce sickly-looking results on human skin.

Tungsten: This setting assumes a color temperature of around 3,200k and is suitable for most tungsten lamps that normally emit a yellow light. This is usually used to correct for the same color cast.

Exposure

A photograph's exposure determines how light or dark an image will appear when it is been captured by your camera. Select the exposure level you prefer from 1 to 9 or auto.

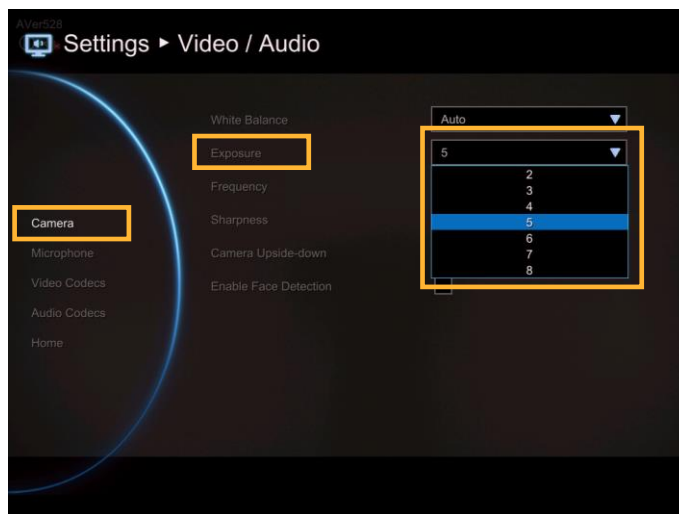

Frequency

Select the correct frequency setting (Auto/50Hz/60Hz/OFF) from the Frequency drop-down list.

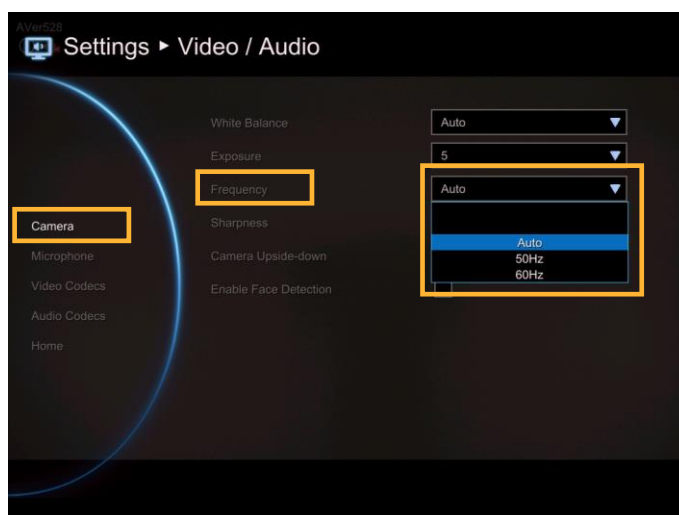

Sharpness

Adjust camera sharpness. The more sharpness the screen image more easy has noise.

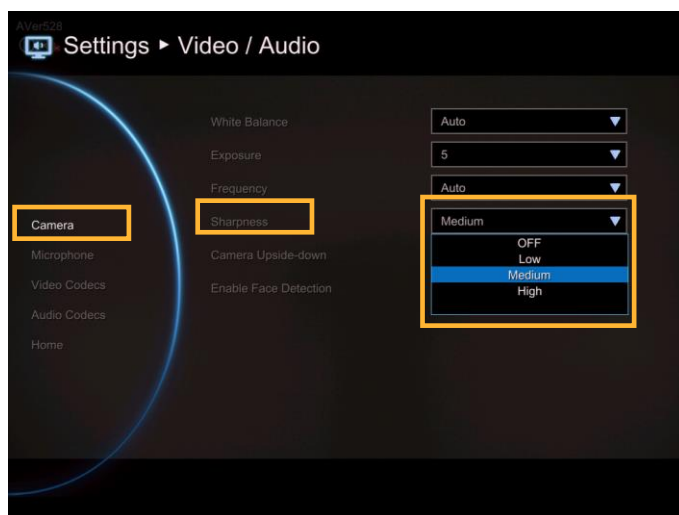

Camera Upside-down

When camera is handed at up-side-down position, enable Camera Upside-down to flip the image view.

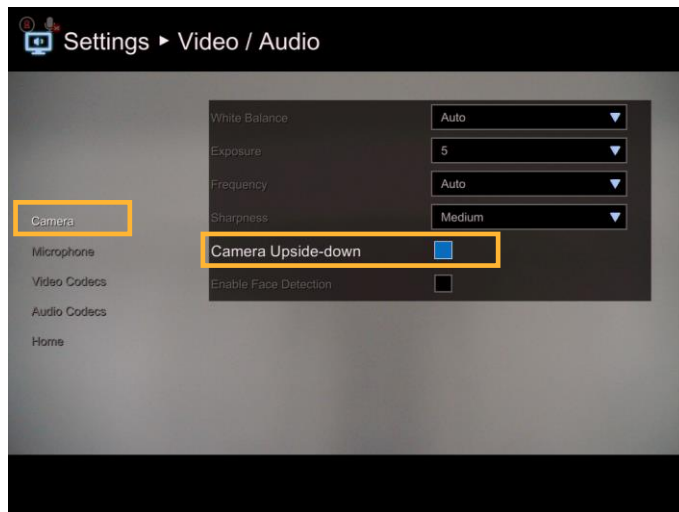

Enable Face Detection

Here allow you to enable face detection function. The camera will adjust focus base on the face that is nearest to camera. The camera only will do the focus adjust at beginning. You can press  button on remote to re-force the camera to do the focus adjusting.

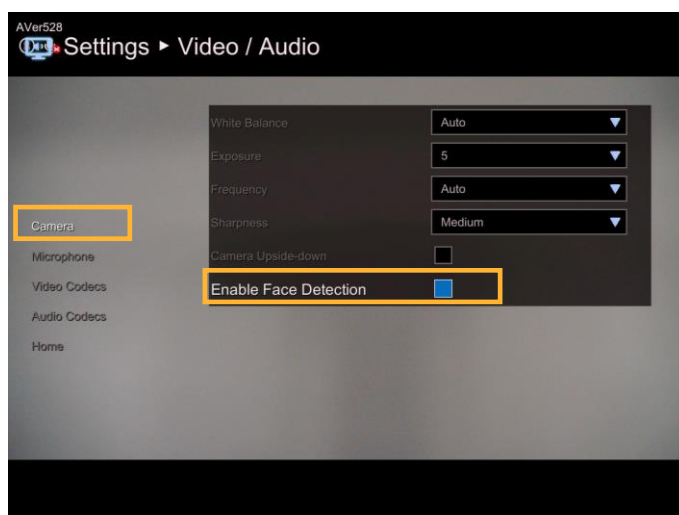

Microphone

EVC main system allows you to adjust the **MIC Gain Level** up to 9 for proper MIC volume to improve audio reception on the microphone (s).

MIC Gain Level

Select Video/Audio | Microphone and press



Adjust the **MIC Gain Level** from the drop-down list.

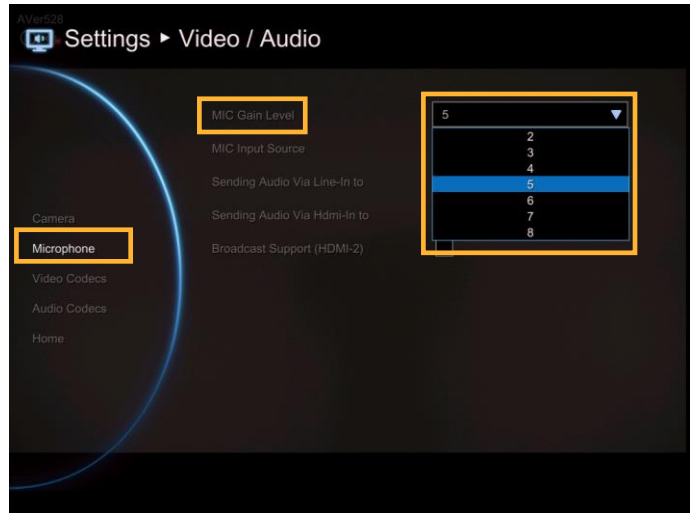

MIC Input Source

Select the source of the microphone from the MIC in or Audio in. If you connect a microphone in AUDIO IN port, we recommend selecting Audio in selection to avoid the echo issue.

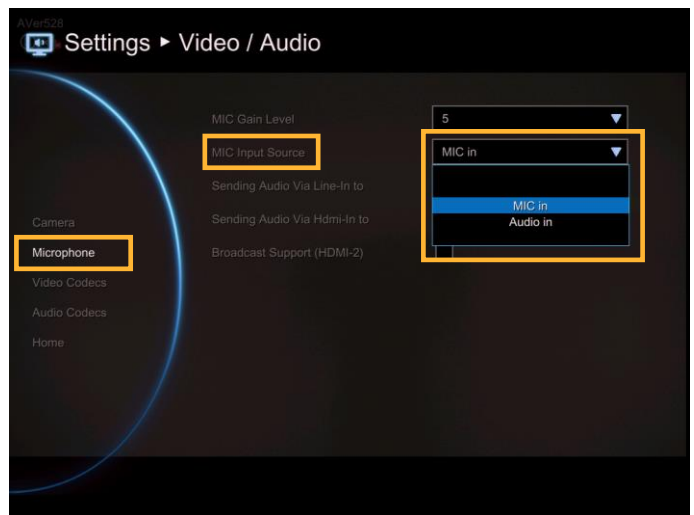

Sending Audio Via Line-in to

Send the audio through the audio device that is connected at audio input port of EVC to selected site(far, near, or both).

If MIC Input Source is **MIC in**, you can choose far, near or both site can hear the audio sound. If MIC Input Source is **Audio in**, only “far site” can be heard the audio sound.

[Note] When audio input port is connected with audio device and enable “Sending Audio Via Line-in to” function, the AVer MIC is disabled.

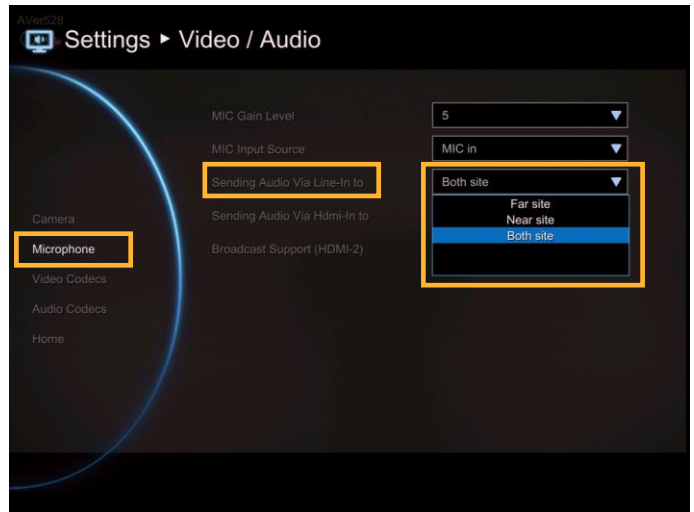

Sending Audio Via HDMI-in to

Send the audio through the device that is connected at HDMI input port. You can choose which site or both site can hear the audio sound.

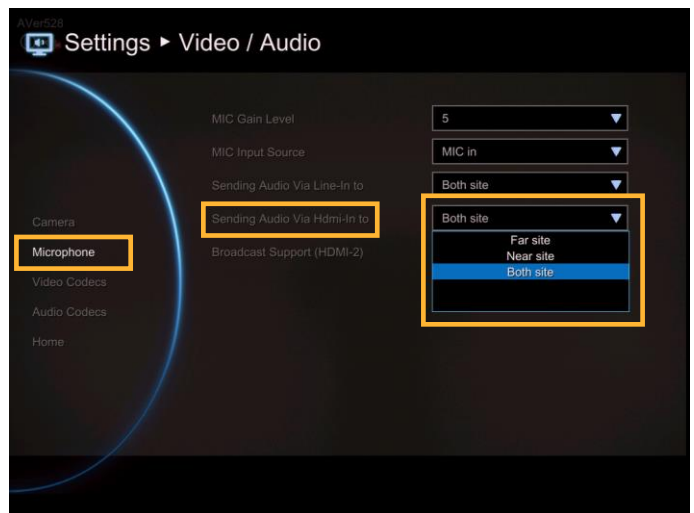

Broadcast Support(HDMI-2)

This function allows you to hear own talking voice during video conferencing through the stream media device that is connected on HDMI-2 port of EVC main unit.

In MIC Input Source, please select “MIC In”.

If the stream media device didn't connect to HDMI-2 port of EVC main unit, it will cause howling when voice come out from TV or speaker.

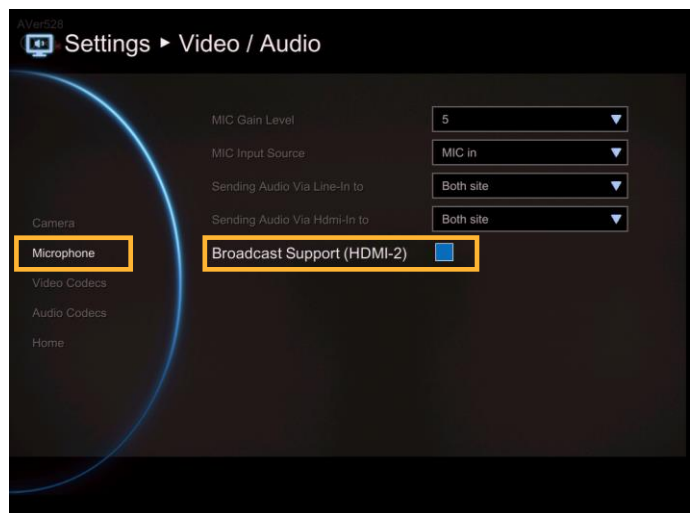

Video/Audio Codecs

You can specify the **Video/Audio Codecs** in **Video Codecs** and **Audio Codecs** configuration screens.

Select **Video/Audio | Video Codecs** for Video Codecs configuration or **Video/Audio | Audio Codecs** for Audio Codecs configuration and press .

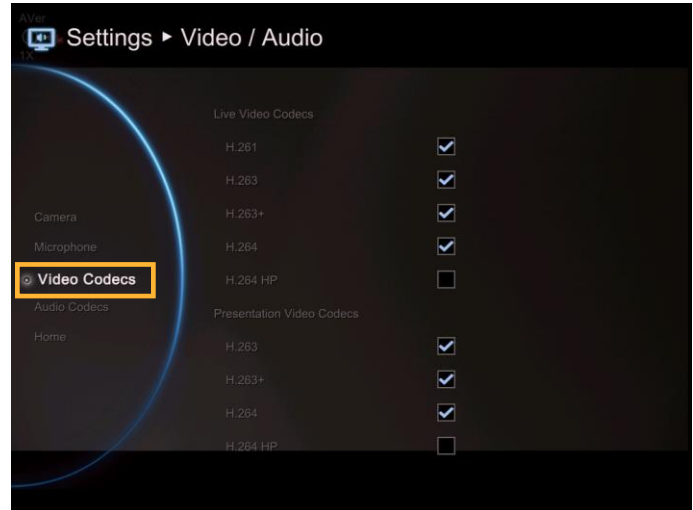



Select the **Video/Audio Codecs** to specify the codecs you want to support. While the EVC supports the H.323 standard coding algorithm, each codec has unique properties and performs best given a certain set of circumstances.

For Video: H.261, H.264, H.263+, H.263, H.264HP, H.264 SVC

[Note] H.261 is always mark in default.

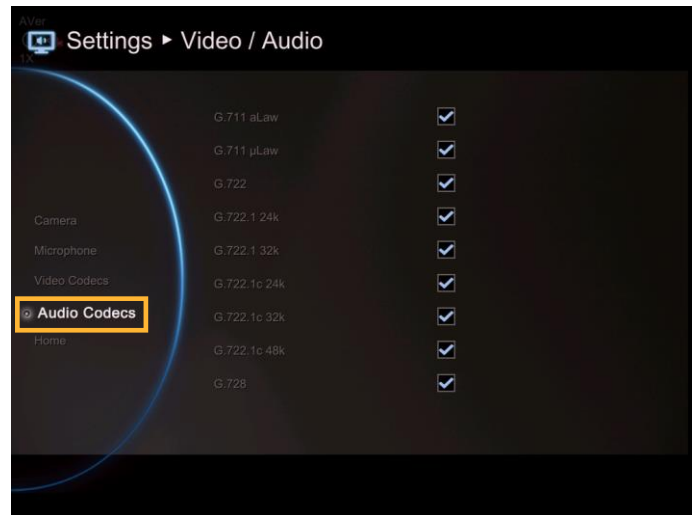
For Audio: G.728, G.722.1C, G.722.1*, G.722, G.711



 Please contact system administrator if you have any question on these codecs.

*:G.722.1/G.722.1C, licensed from Polycom®

Network

Network allows you to set the **SIP Server**, **Gatekeeper**, **Firewall** and **LAN Configurations**. Before configuring Network and Firewall, please refer to page 69 – Scenarios for LAN connection and follow the instructions of your actual network connection scenario.



LAN Configuration

AVer EVC supports **IPv4** and **IPv6** internet protocol for your configuration. IPv4 is the most widely deployed internet protocol used to connect devices to the internet. IPv4 uses a 32-bit address scheme, written in decimal as four numbers separated by periods. Each number can be zero to 255. For example, 192.168.0.1 could be an IP address.

Select Network | LAN Configuration and press .

Configure the following relative items to setup the LAN Configuration.

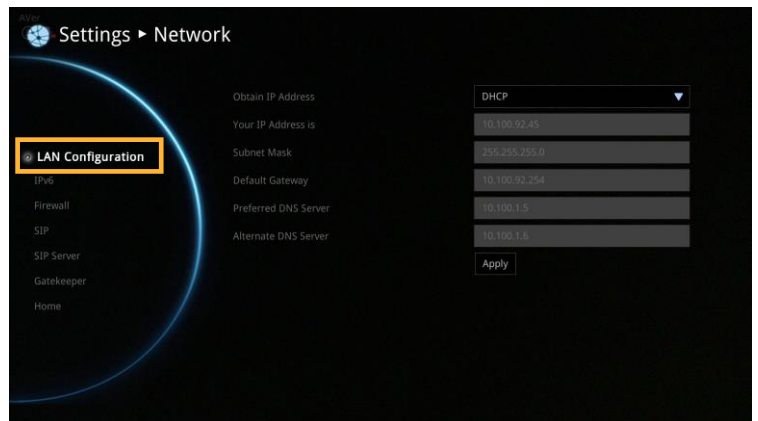

Obtain IP Address

DHCP: Configure the system to automatically obtain an IP address from the DHCP server.

Static IP: Configure the system to use the assigned IP address. Select this when the public IP address is available.

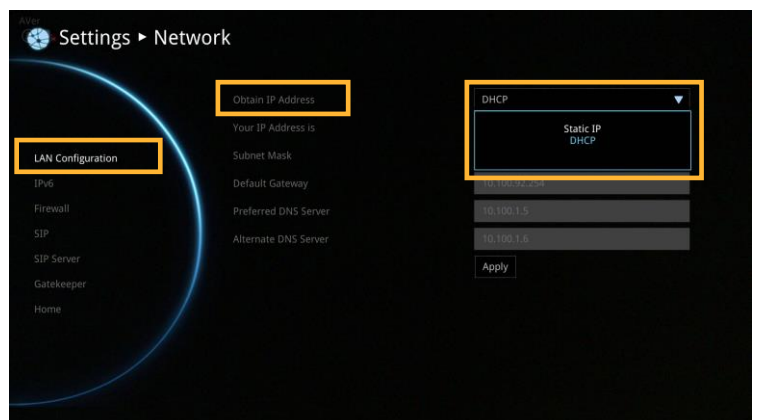

Your IP address is

Show the current IP address; enter into when you need to configure your IP address manually.

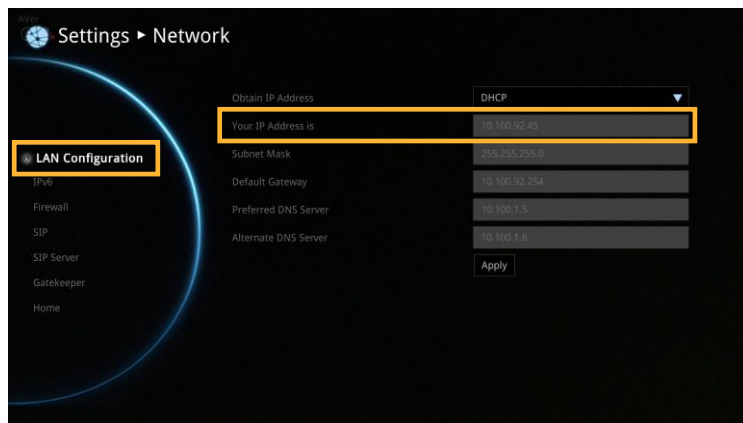

Subnet Mask

Show the designated IP address routing prefix; enter the subnet mask address when the system does not automatically obtain the subnet mask

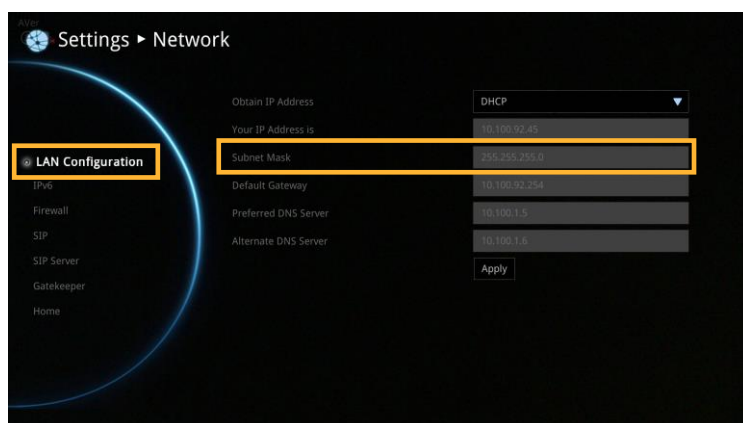

Default Gateway

A gateway is a network point that acts as an entrance to another network. Enter the gateway address when the system does not automatically obtain the gateway.

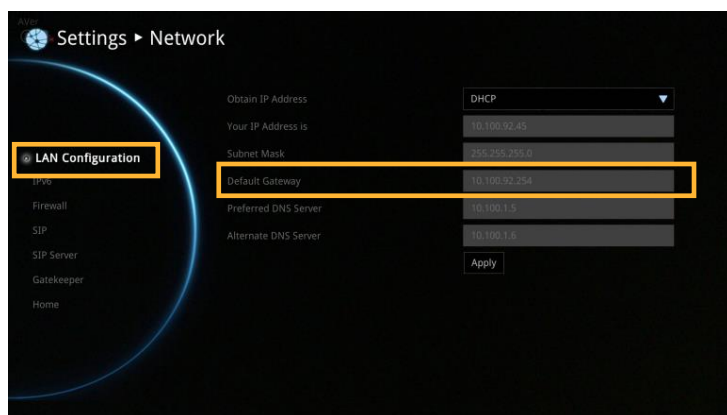

Preferred/Alternate DNS Server

Domain Name System (DNS) servers convert human friendly names (for example: `www.example.com`) to IP addresses (`218.77.272.166`) that let machines be found on the network. The preferred DNS server is the one your computer asks first. The alternate is a backup. Enter the Preferred and Alternated DNS Server address.

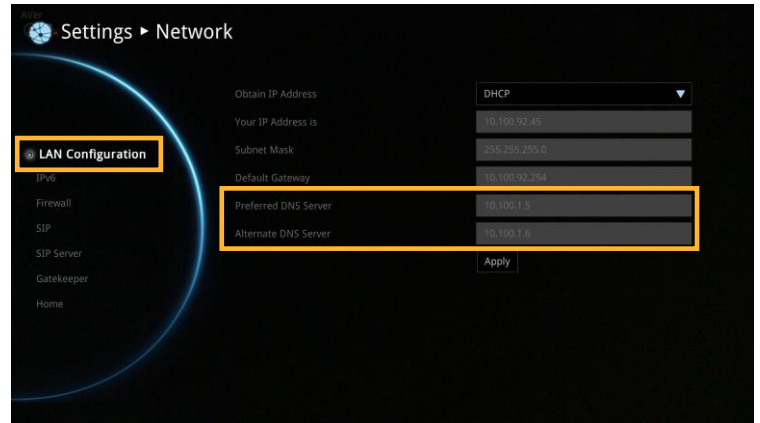

After finishing all settings, select **“Apply”** to active the changed settings.

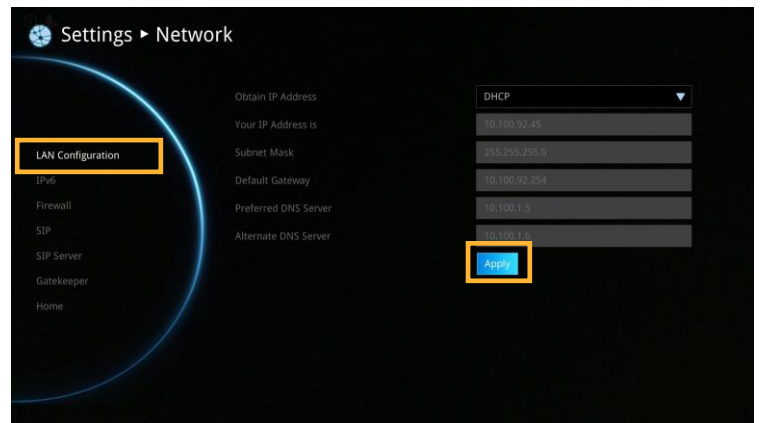

LAN Configuration (IPv6)

IPv6 is an evolutionary upgrade to the Internet Protocol. IPv6 will coexist with the older IPv4 for some time. IPv6 addresses are 128-bit IP address written in hexadecimal and separated by colons. An example IPv6 address could be written like this: `300E:1389:3030:72EB:1D71:414B:1079:6AF3`. Some types of addresses contain long sequences of zeros that can be compressed (the address of `fc00:0000:0000:0000:0000:0000:0000:0001` can be compressed to `fc00::1`).

Select Network | LAN Configuration (IPv6) and press .

Configure the following relative items to setup the LAN Configuration (IPv6).

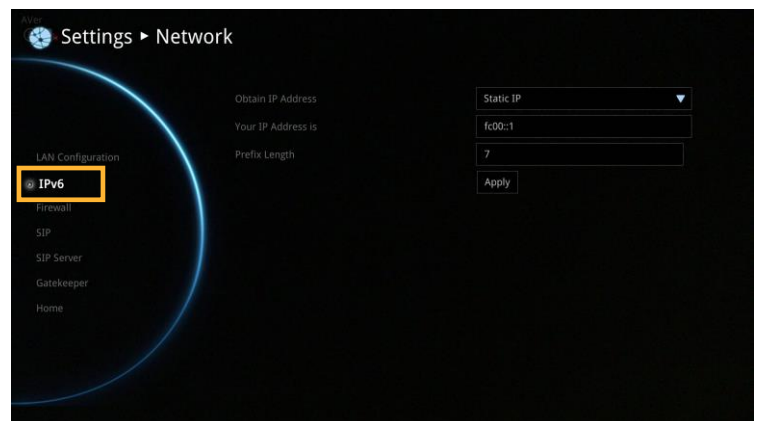

Obtain IP Address

Static IP: Configure the system to use the assigned IP address. Select this when the public IP address is available.

Auto: Obtain the dynamic IP address automatically.

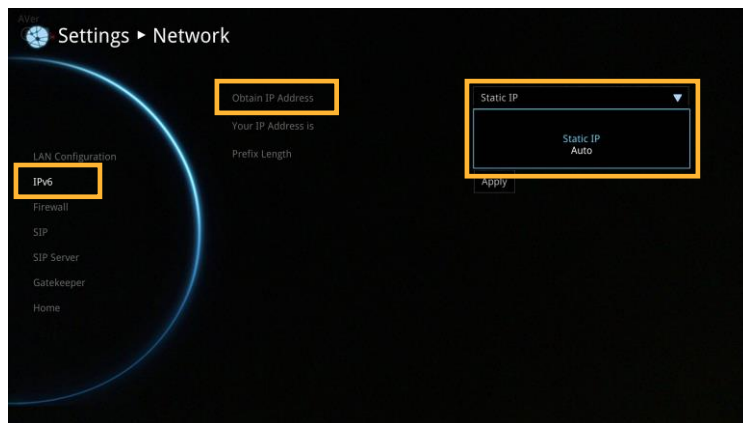

Your IP Address is

Show the current IP address; enter into when you need to configure your IP address manually.

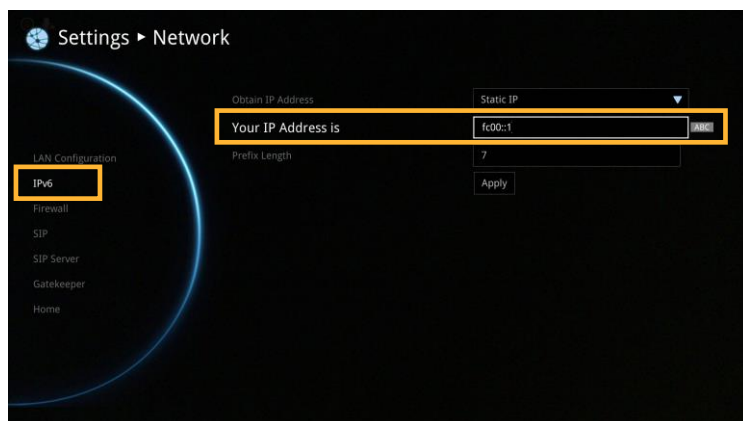

Prefix Length

Prefix Length allows you to place as many IPv6 devices as the underlying network medium allows.

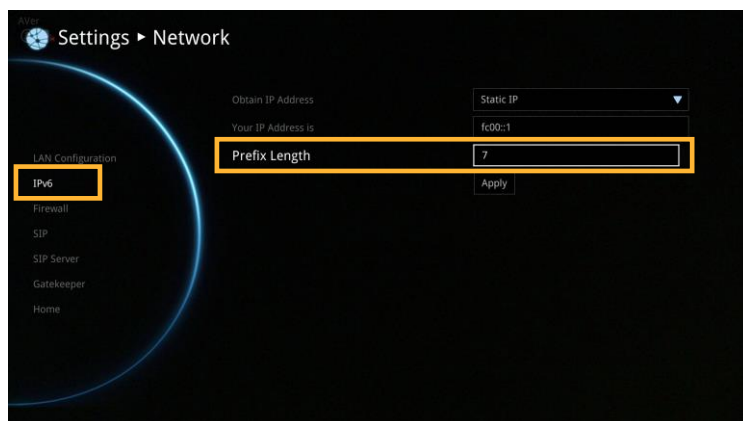

After finishing all settings, select **“Apply”** to activate the changed settings.

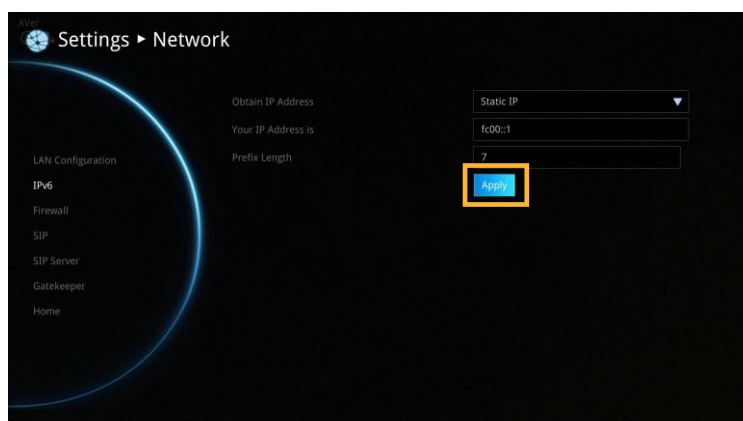

Firewall

Configure the following items to setup the Firewall.

Select **Network** | Firewall and press .

Configure the following relative items to setup the Firewall.

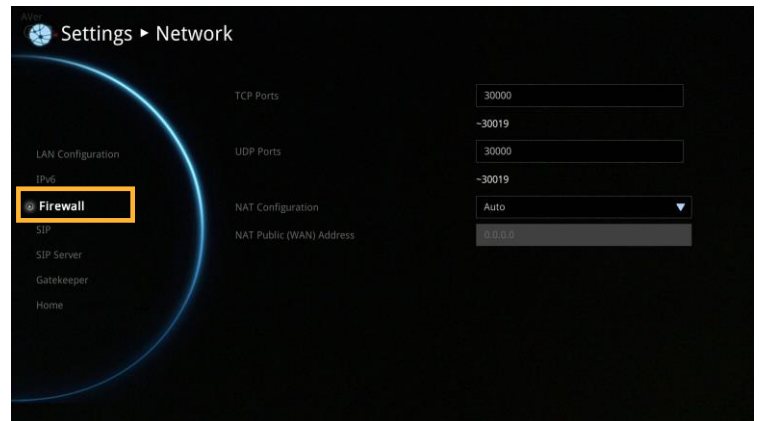

TCP/UDP Ports

By default, the system communicates through TCP/UDP ports in the range from 30000 to 30299. You can specify the range for your specific network environment.

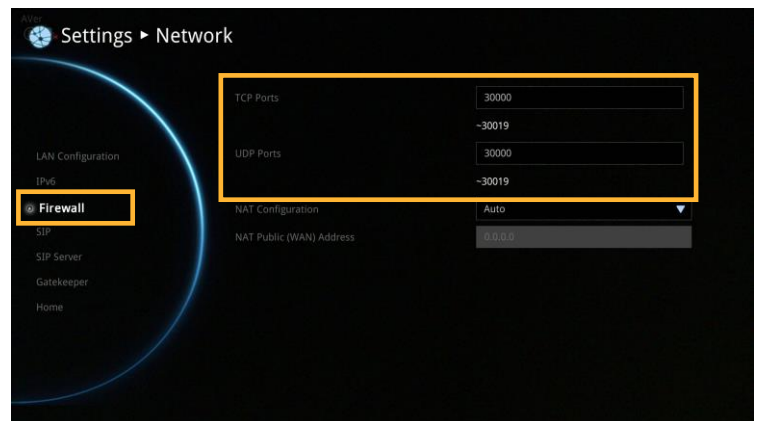

 You must configure your firewall to allow inbound/outbound traffic through “UDP (port 1719)”/ “TCP (port 1720)” for H.323 call setup.

NAT Configuration

AVer EVC supports NAT systems that use the internal IP addresses to communicate with other devices outside the LAN.

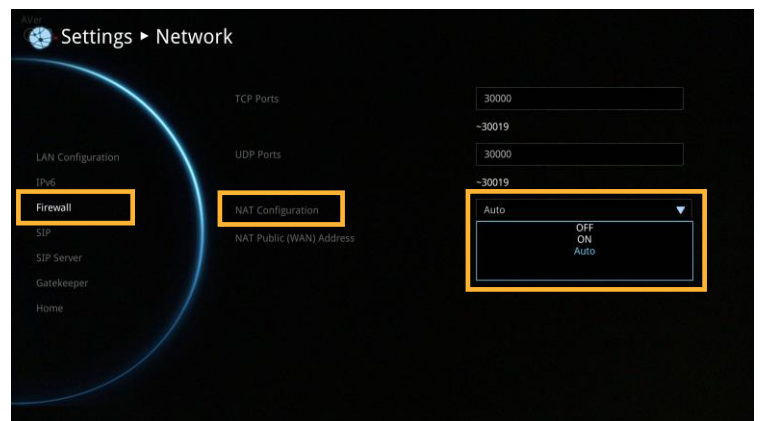

NAT Public (WAN) Address

The NAT public address must be entered when you enable the feature on NAT configuration.

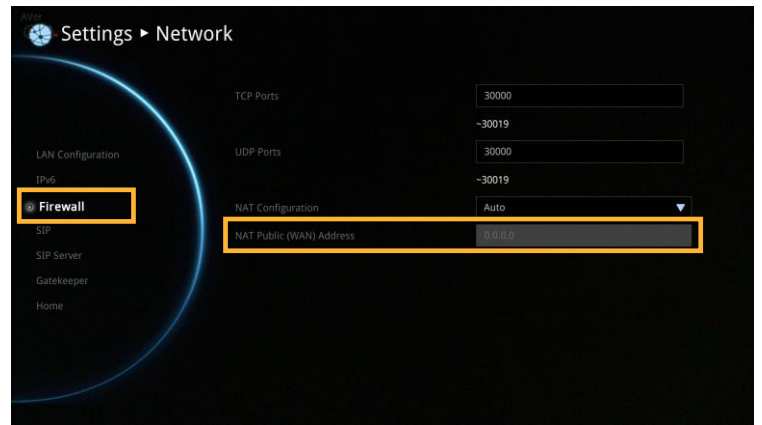

SIP

Session Initiation Protocol (SIP) allows you around the world to communicate using your supported devices over the Internet.

Select **Network** | **SIP** and press .

Configure the following relative items to setup the SIP.

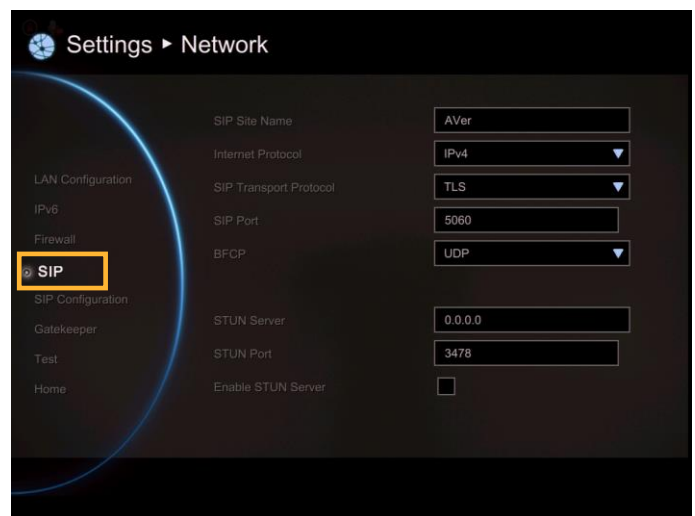

SIP Site Name

Enter the SIP site name for others to identify. The SIP site name may be the same or different than the domain for Web activity.

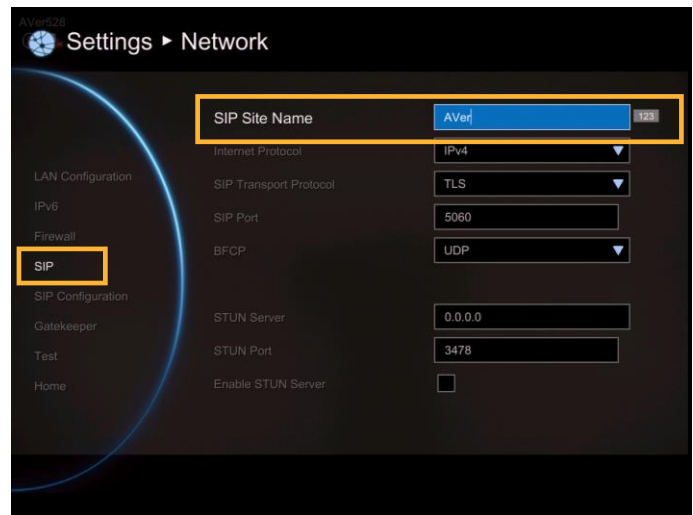

Inter Protocol

Select internet protocol check box to enable IPv4 or IPv6 protocol using.

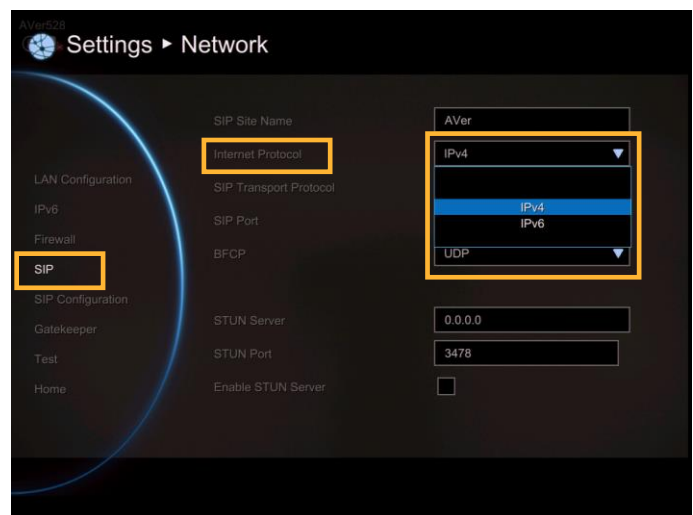

SIP Transport Protocol

Select the SIP Transport Protocol type from the drop-down list for using. There are two types of Internet Protocol (IP) traffic. They are Transmission Control Protocol (TCP) and User Datagram Protocol (UDP). To ensure proper connection, verify if both calling parties are using the same transport protocol. By default, it is set to UDP.

TCP: TCP is connection oriented. Once a connection is established, data can be sent bidirectional.

UDP: UDP is a simpler, connectionless Internet protocol. Multiple messages are sent as packets in chunks using UDP.

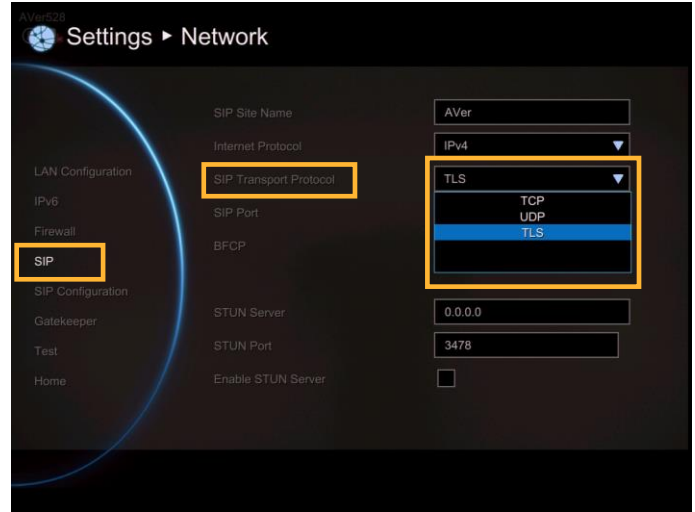

SIP Port

Change this value only if you use specific settings in your network system. By default, the SIP port is set to 5060.

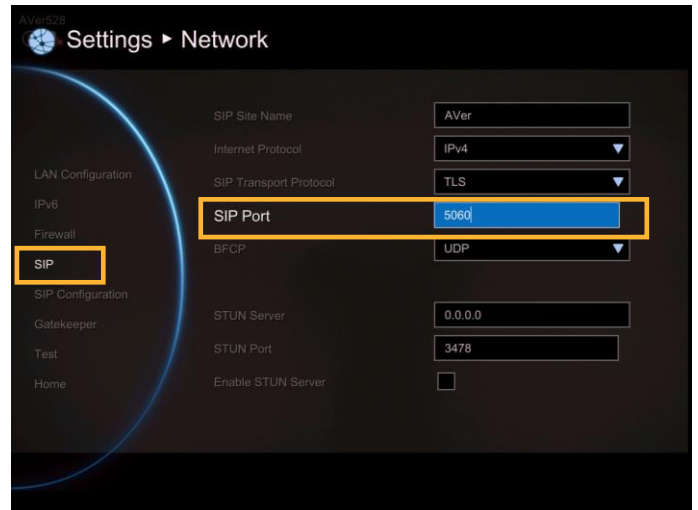

BFCP

Enable presentation sharing function in SIP. It allows you to share the presentation file screen to other caller in video conference meeting.

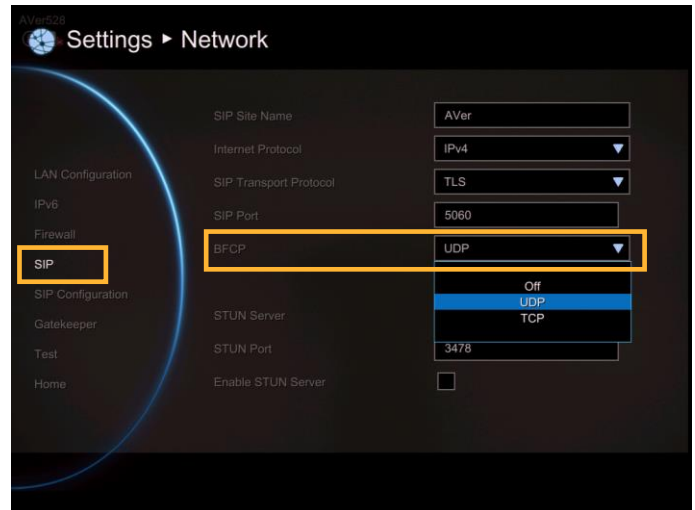

STUN Server

STUN (Session Traversal Utilities for NAT) is a standardized set of methods and a network protocol to allow an end host to discover its public IP address if it is located behind a NAT.

Enter IP address of SIP NAT traversal server.

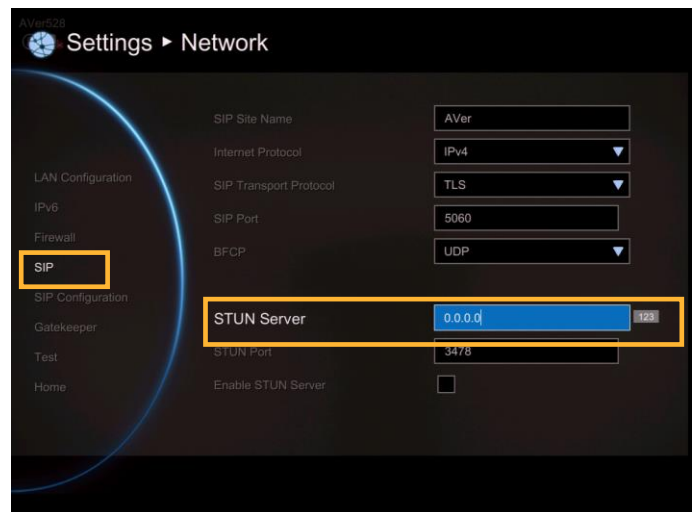

STUN Port

Enter port number of STUN server.



Enable STUN Server

Mark to enable STUN server function.

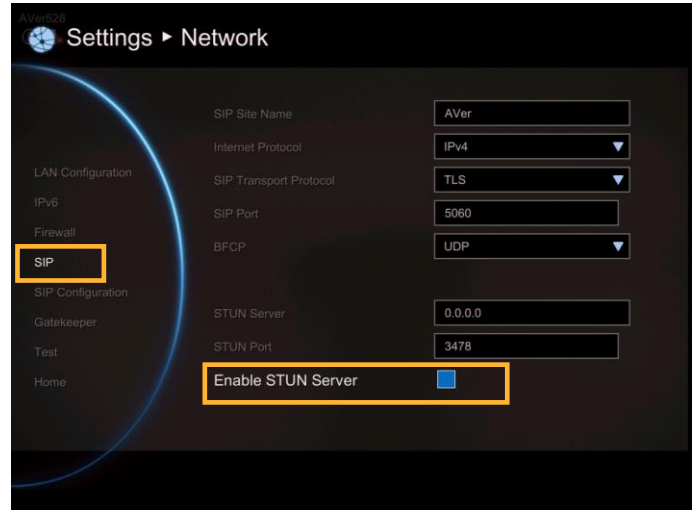

SIP Configuration

A typical SIP session involves a client requesting a session with a SIP server. After the request is received, the SIP server returns a response to the user indicating the availability of the session.

1. Select Network | SIP Configuration and press .
2. Configure the following relative items to setup the Server.

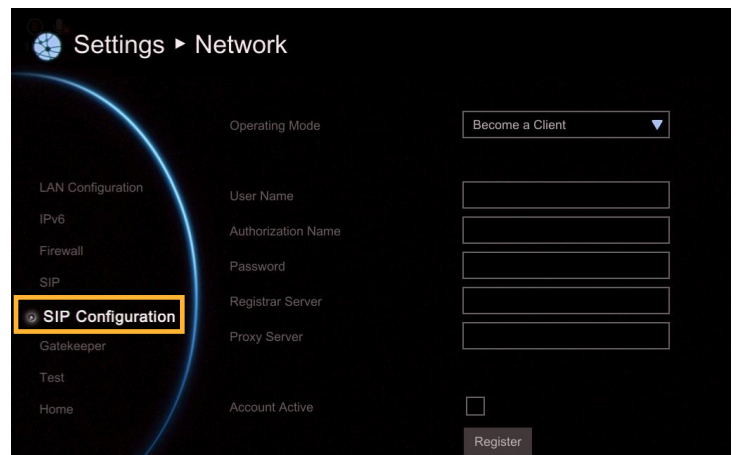

Operating Mode

Select Operating Mode and press  to select the mode from drop-down list.

Become a Client: Register EVC main system to SIP external server.

Become a Server: Set EVC main system as a SIP server.

[Note] Only allow the users are registered on EVC300 / EVC900 series SIP server can make a connection.

OFF: To deactivated using SIP.

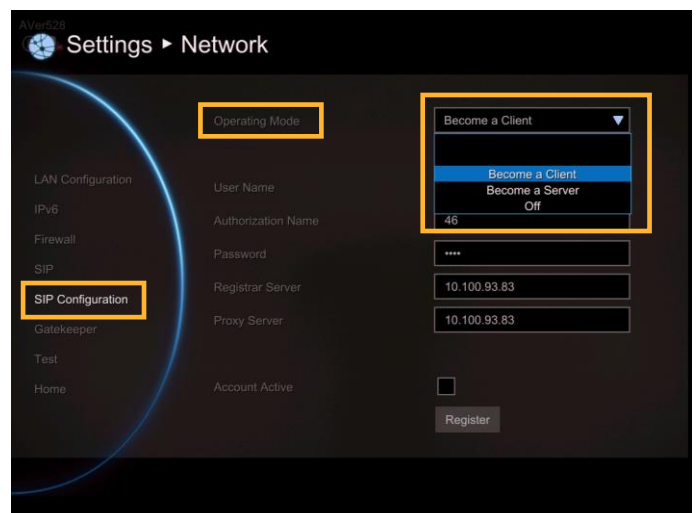

Become a Client: Select Operating Mode is “Become a Client” in SIP Configuration. Then, enter the following information to register to SIP server.

User Name

Select User Name and press  to enter user name.

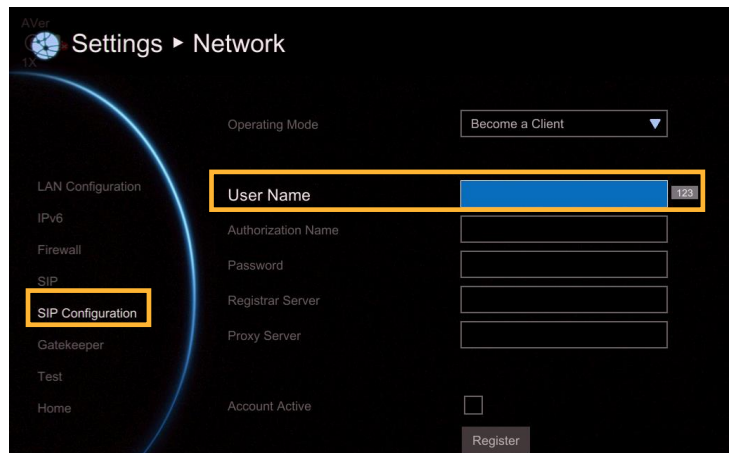

Authorization Name

Select Authorization Name and press  to enter authorization name.

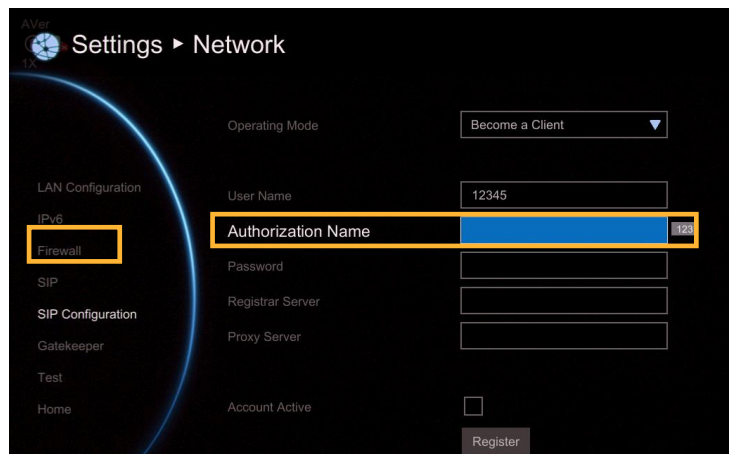

Password

Select Password and press  to enter using password.

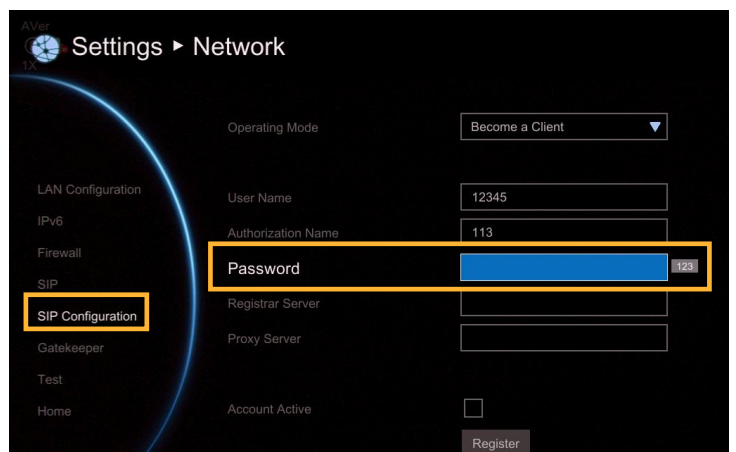

Registrar Server

Registrar Server accepts registrations from users and places these registrations, (which is essentially location information), in a database known as a location service. Enter the Registrar Server name that you want to use.

The screenshot shows the 'Settings > Network' interface. The 'SIP Configuration' menu item is highlighted with a yellow box. In the configuration area, the 'Registrar Server' field is highlighted with a yellow box and contains the text '123'. Other fields include 'Operating Mode' (Become a Client), 'User Name' (12345), 'Authorization Name' (113), and 'Password' (masked with dots). A 'Register' button is visible at the bottom right.

Proxy Server

Proxy Server is computing device (typically a server) that interfaces between data processing devices and others within a communications network. These devices may be located on the same local area network or an external network. Enter the used Proxy Server name.

The screenshot shows the 'Settings > Network' interface. The 'SIP Configuration' menu item is highlighted with a yellow box. In the configuration area, the 'Proxy Server' field is highlighted with a yellow box and is empty. The 'Registrar Server' field above it contains '10.100.93.68'. Other fields include 'Operating Mode' (Become a Client), 'User Name' (12345), 'Authorization Name' (113), and 'Password' (masked with dots). A 'Register' button is visible at the bottom right.

Account Active

Select “**Account Active**” check box and press  to activate/deactivated.

Next, go to **Register** button and press  to register to the SIP server.

The screenshot shows the 'Settings > Network' interface. The 'SIP Configuration' menu item is highlighted with a yellow box. The 'Account Active' checkbox is checked. The 'Register' button is highlighted with a yellow box. The configuration area shows 'Registrar Server' as '10.100.93.68' and 'Proxy Server' as '10.100.93.68'. Other fields include 'Operating Mode' (Become a Client), 'User Name' (12345), 'Authorization Name' (113), and 'Password' (masked with dots).

Become a Server: Select Operating Mode is “Become a Server” in SIP Configuration. Then, enter the following information to be a SIP server.

Authentication Mode

Select authenticate way to authorize SIP client.

Anonymous: No password required for any SIP client.

Password: Password is required for SIP client to connect SIP server. Set the password in Password column.

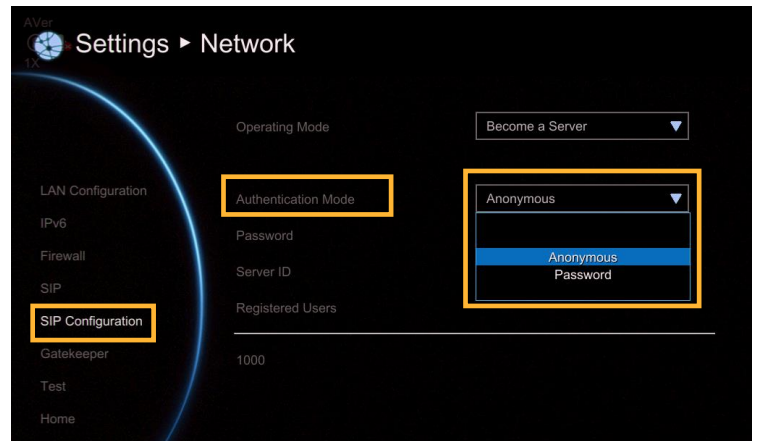

Password

When authentication mode is Password mode, a password is required to be set. The default password is “1234”.

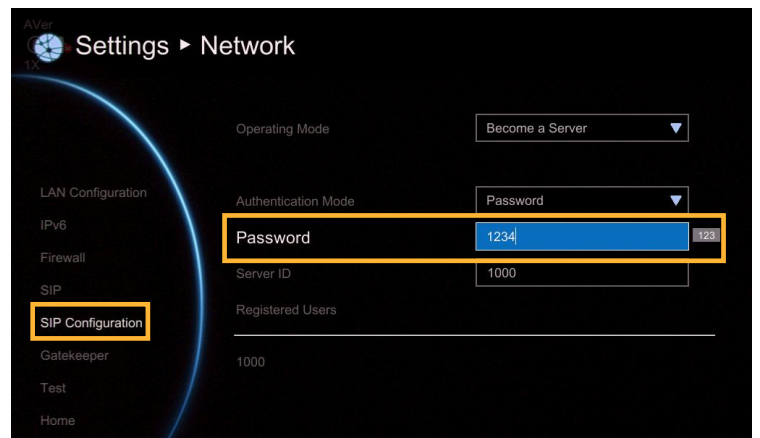

Server ID

The SIP server’s ID that wants to connect. The EVC300 / EVC900 series default server ID is “1000”.

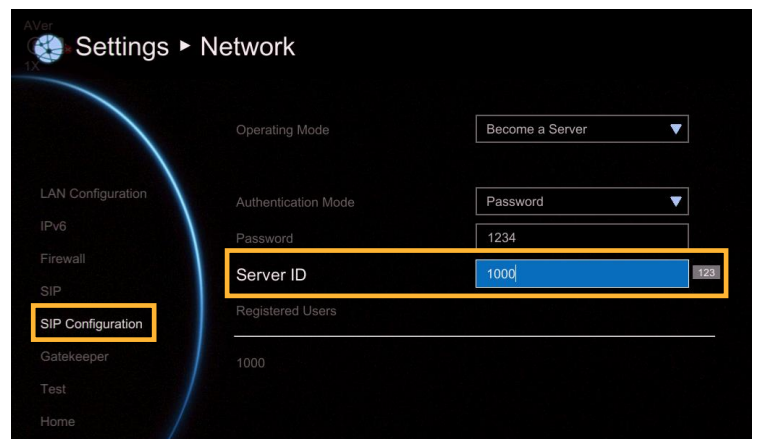

Registered Users

List all registered SIP client.

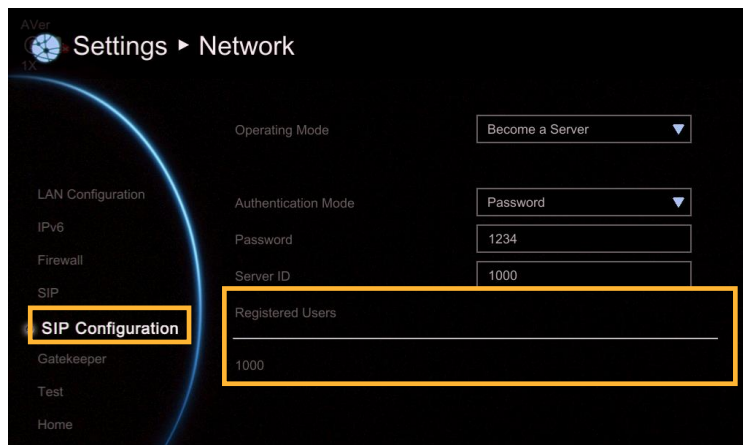

Gatekeeper

The **Gatekeeper** in AVer EVC serves the purpose of translating services from E.164 IDs to IP addresses in an H.323 network.

Select Network | Gatekeeper and press .

Configure the following relative items to setup the Gatekeeper.

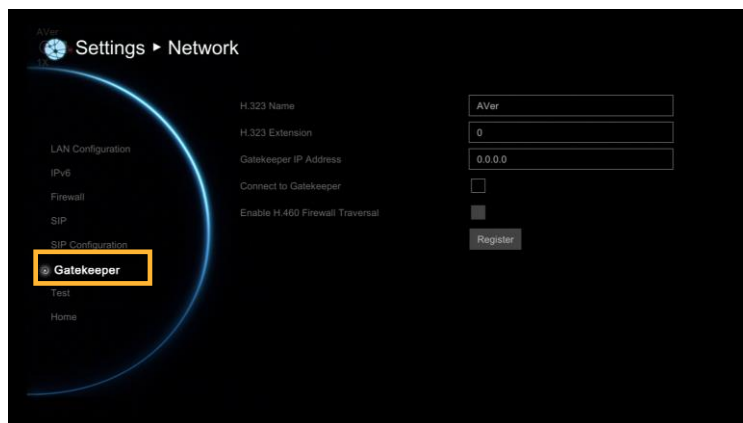

H.323 Name

Specify the name that gatekeepers and gateways can use to identify this system. Enter the name; the gatekeeper will use this name for identification.

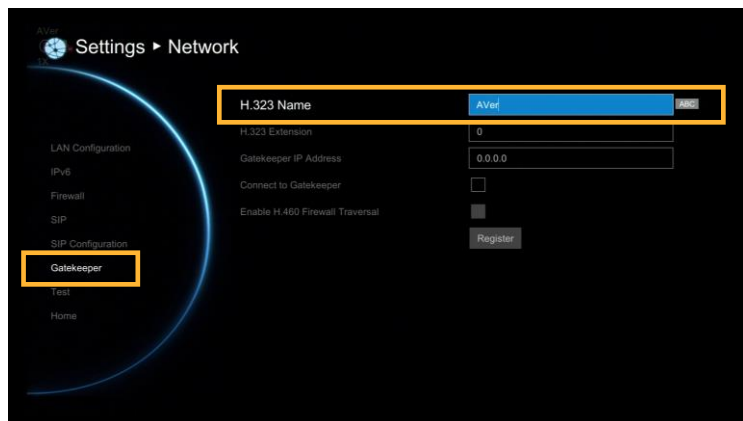

H.323 Extension

Enter a numeric value for the gatekeeper to identify your system further.

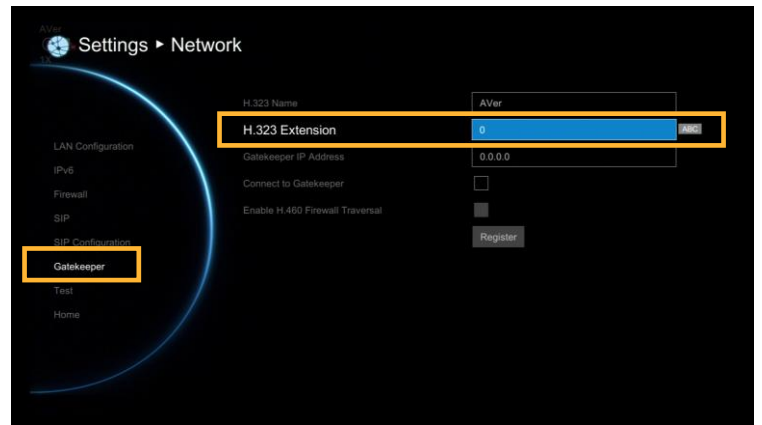

Gatekeeper IP Address

Enter the IP address for the gatekeeper server.

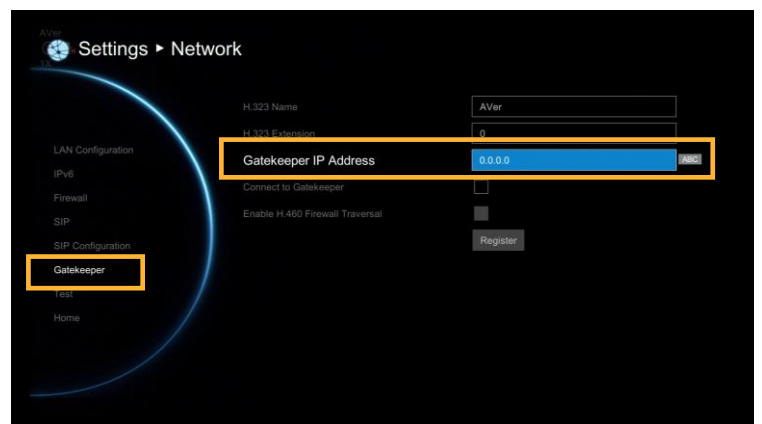

Connect to Gatekeeper

Select this check box to Activate/deactivate gatekeeper.

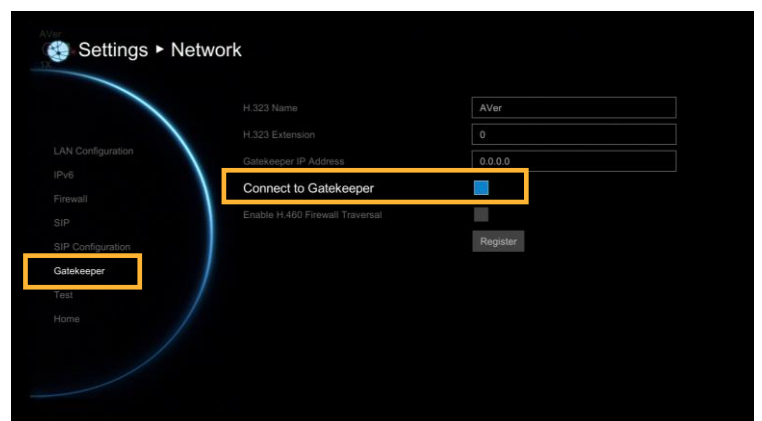

👉 Make sure to setup the Gatekeeper before setting up the Firewall.

Enable H.460 Firewall Traversal

If you want to enable the H.460 Firewall Traversal, please set the following ports in port forwarding in your firewall before start installing your EVC.

Port	Function	Type
1719	Gatekeeper	UDP
1720	H.323 Call setup	TCP
30000~30299	Control and media for audio, video, content, and data/FECC	TCP and UDP
80	HTTP Interface (WebTool)	TCP
23	Telnet	TCP
5060	SIP	TCP and UDP

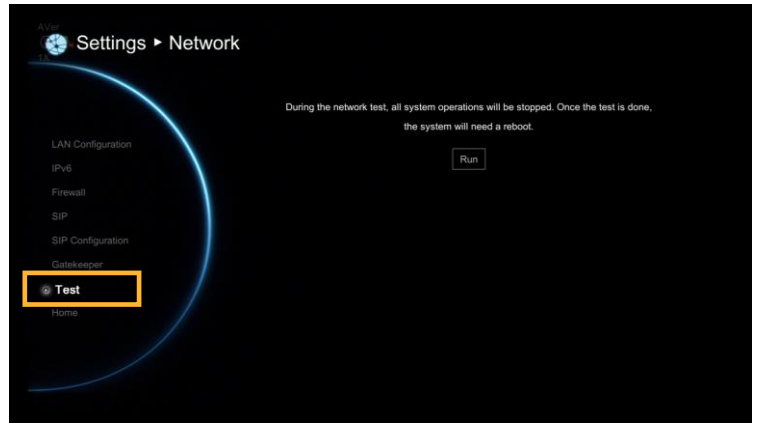

👉 Make sure your gatekeeper supports H.460 Firewall Traversal before enabling it.

Test

This feature tests the network ability between local and far site.

Select Network | Test and press .

Select Run to start testing.

Wait until it finishes the network test. The check mark will appear if the network test is successful. If it fails, save the report in a USB flash drive and contact our technical support.

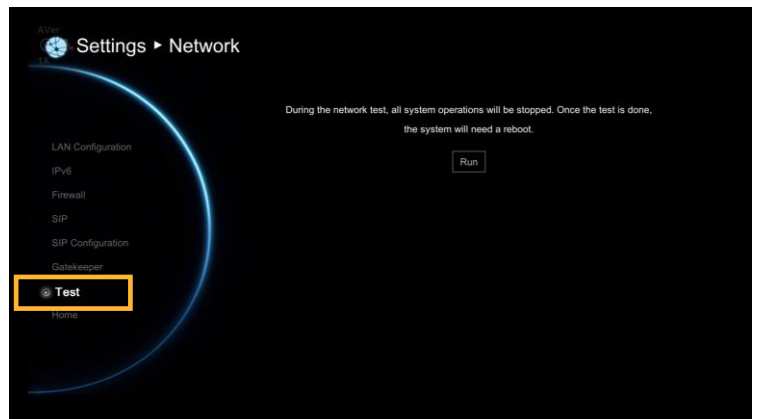

Web Configurations

You can use the internet browser to access your AVer EVC system through a LAN RJ-45 cable to setup a AVer EVC system remotely. You can also access the Phonebook to add, edit and delete entries, view and download the call history, update the system, and restore your previous settings. For web configurations, your AVer EVC system default IP address is: 192.168.0.1.

☞ Please change your EVC's IP address at the start.

Using the WebTool

Enter your EVC's IP address in the URL field. You will need to enter admin password to log in. In WebTool login screen, user can select the Language of Web Tool and enter the password, click Submit button to login.

☞ Default password is 1234

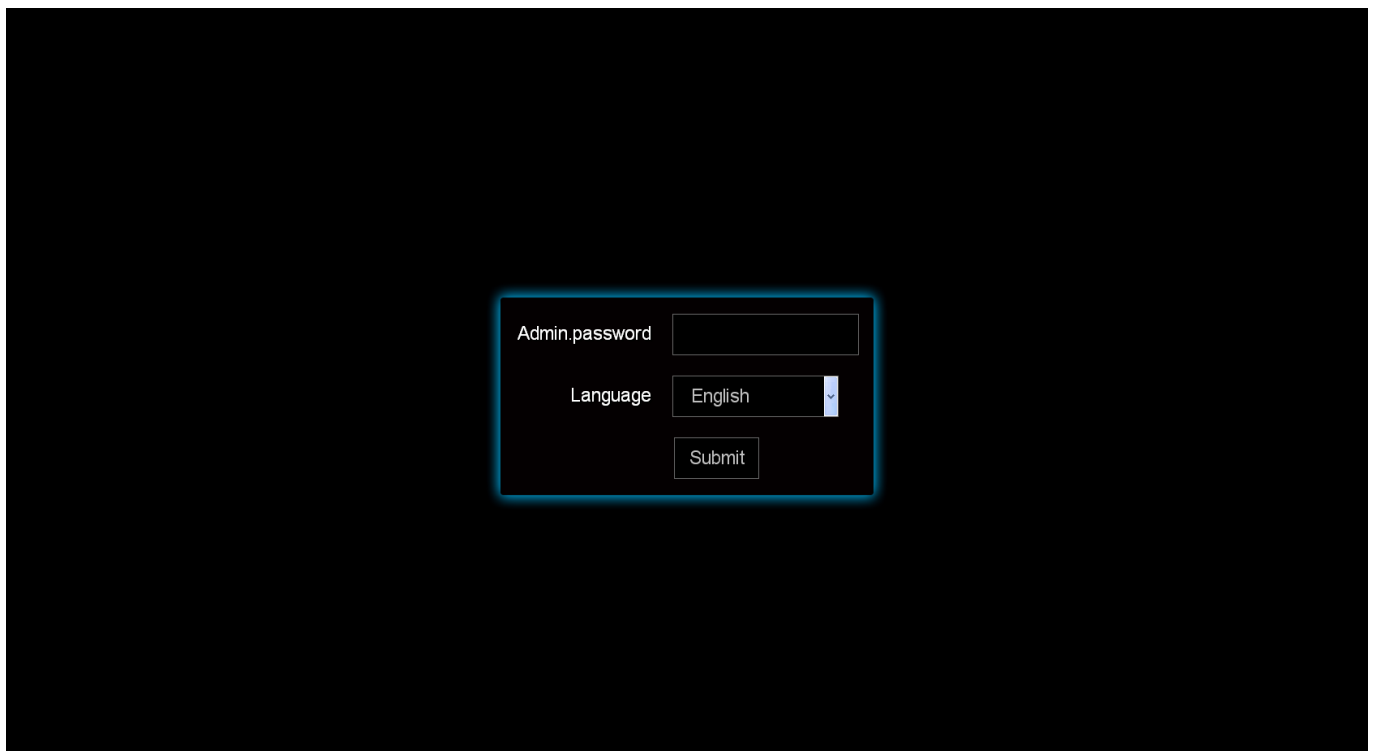

After login, user should see the video screen of local site.



is indicated in background view mode.



is indicated in live view mode.



3. Click  icon can call out on-screen remote controller. You can use mouse to click the on-screen remote controller to operate functions on WebTool.



In the WebTool page, you can access the following:

- Phonebook
- Dial
- Call History
- Video/Audio
- General Setting
- Network

☞ You can use the mouse to click the specified icon for a selection.

☞ In WebTool, all functions are same as on EVC system.

Managing Phonebook

In the Phonebook page of WebTool, all functions are the same as your AVer EVC Application. One different is the Upload/Download.

Edit and Save

1. Locate and open the file using MS Excel and select Office XML Handler to create a schema based on the XML source data.

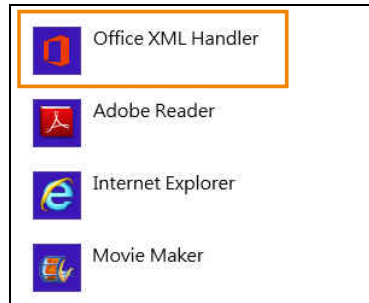

2. Edit the file.

	A	B	C	D	E
1	site	h323	call_quality	group	sip
2	China	10.100.91.49		256 Branch office	
3	US			512 Branch office	1234
4	SUPER	192.168.0.1		64 Customer	
5	Avte			1024 Customer	10.100.93.68
6	Jack Lin	192.168.0.8		64 Customer	
7	Lucky			768 Customer	10.100.93.67

3. Make sure to save the file as XML Data so it can be uploaded back to the system.

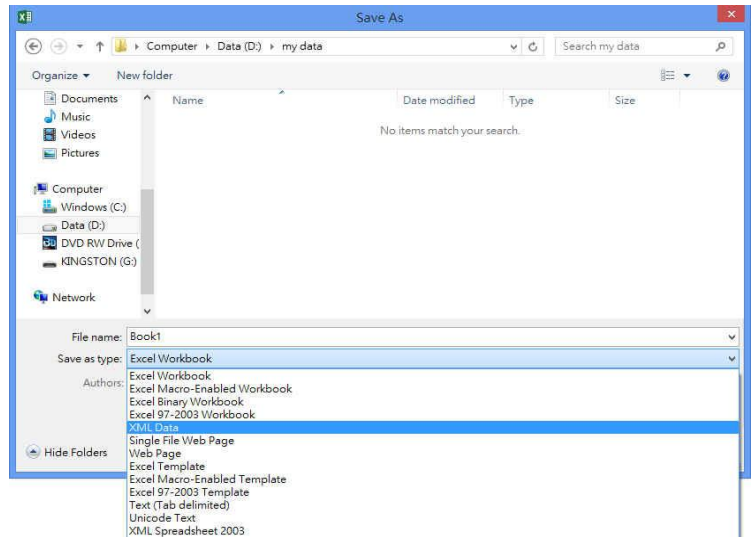

Download Phonebook Entries

Download allows you to download contact data from your AVer EVC system.

1. Click Phonebook | Upload/Download.
2. The saving Phonebook data from AVer EVC system dialogue box will appear.

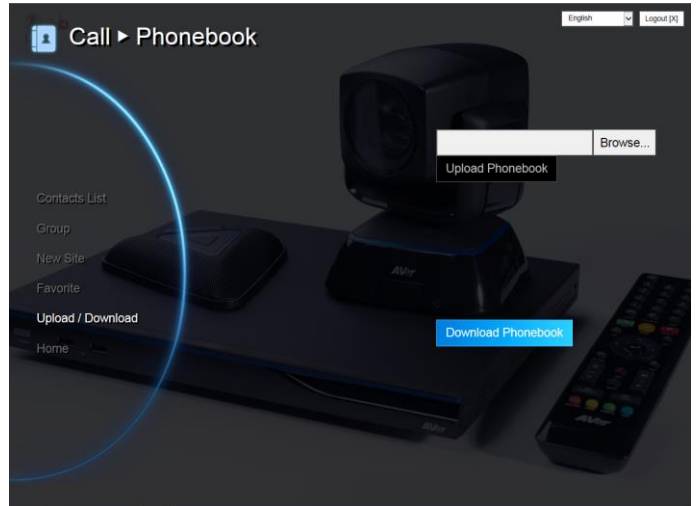

3. Click "Save" to save the file.
4. After saving, you have to re-arrange your browser to update your WebTool Phonebook so that it can be the same as your EVC system.

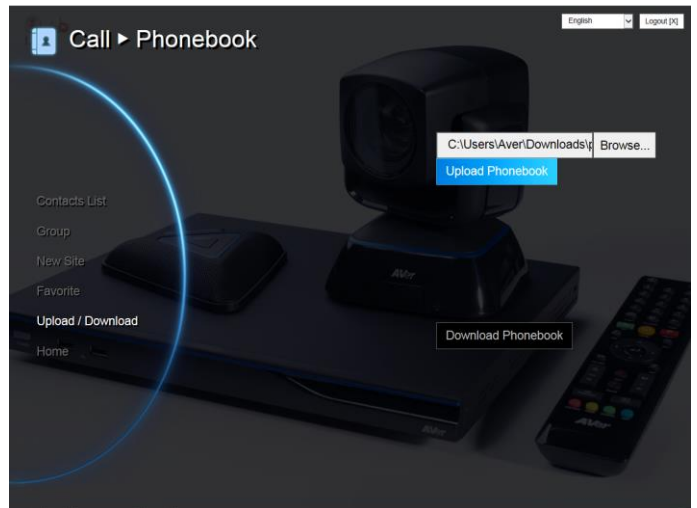

Upload Phonebook Entries

Upload allows you to upload the data that you have edited or added from your WebTool to your AVer EVC system.

1. Click Phonebook | Upload/Download
2. Click "Upload Phonebook" to upload edited or added contents to your AVer EVC system directly.
3. You can also click "Browser" to open the Phonebook file .xml saved in your PC to upload it to your AVer EVC system.
4. After completing upload, the contents of Phonebook on your AVer EVC system will be modified in time.

👉 You can also download the phonebook entries and upload them to another AVer EVC unit.

System Update

Update System

You can update the latest EVC firmware to your AVer EVC system from AVer EVC WebTool.

1. Click General Setting | System Update
2. Click "System Update".

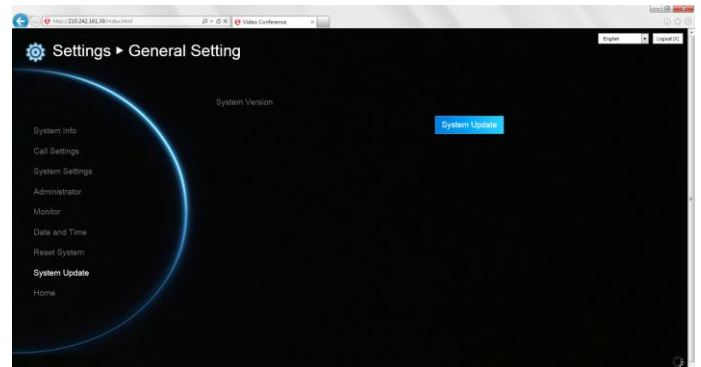

3. Click "Select" to browse and locate the downloaded firmware file .dat.



4. Click "Submit" to begin the system update or Cancel to stop this operation.

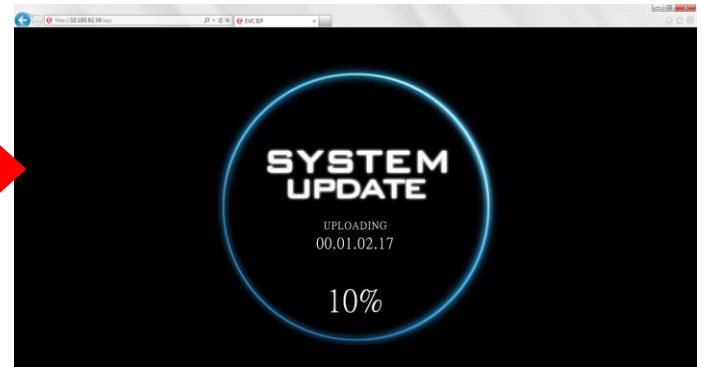
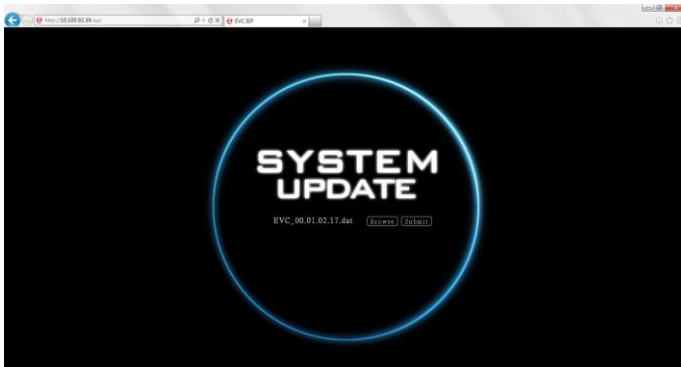

WARNING! Please do not perform any operations during the updating process.

Troubleshooting

Audio

Can't hear the audio during a call

- Make sure the MICs are not muted.
- Make sure the MIC and speaker connections are properly connected as illustrated in the manual.
- Make sure the MIC and speaker device are workable.
- Ensure proper volume level on the system.

The audio quality is poor

- Ensure the MIC is not damaged.
- Try to adjust the "Mic Gain Level".
- Make sure the MIC is not facing the output speakers to prevent echo.

Video/Display

Video conference call is established but no video or voice.

- If you are connecting to AVer EVC with firewall, make sure you have done the port forwarding correctly. For non H.323 ALG firewall, please set the NAT configuration and the WAN IP address on AVer EVC system is entered.
- We suggest having a fixed public IP address for AVer EVC system. With Dynamic public IP address, it will change after a certain period which depends on your local ISP.
- There is a routing issue if you installed two AVer EVC systems sharing one public IP address.

Unable to connect to other video conferencing systems.

- Check to see if you dial the correct IP address.
- Ensure the power status of the device from the other site is on.
- Verify if the firewall blocks the inbound traffics from the other site.
- Verify if the other site rejected your video conferencing call.

Unable to see the OSD.

- Check to see if your cable is connecting correctly.
- Make sure your system and display are well-connected and then reboot your system. (Your display should be switched on before you reboot your system.)
- Press "Dual" button on remote controller (User needs to keep pressing until OSD menu is shown).

Why can't I see the UI configuration screen after connecting the VGA cable and powering on AVer EVC systems upon screen saver mode?

- Please plug and unplug the VGA connector again to re-connection the VGA cable.

Network

The LAN connection is fail.

- Make sure you have changed your default IP address. The default IP address is 192. 168.0.1, in order not to conflict with other devices in the same LAN, please change your IP address at the start.

Cannot open WebTool by IE9 and IE10.

1. Click  (General Setting icon) in IE.
2. Select "F12 developer tools".

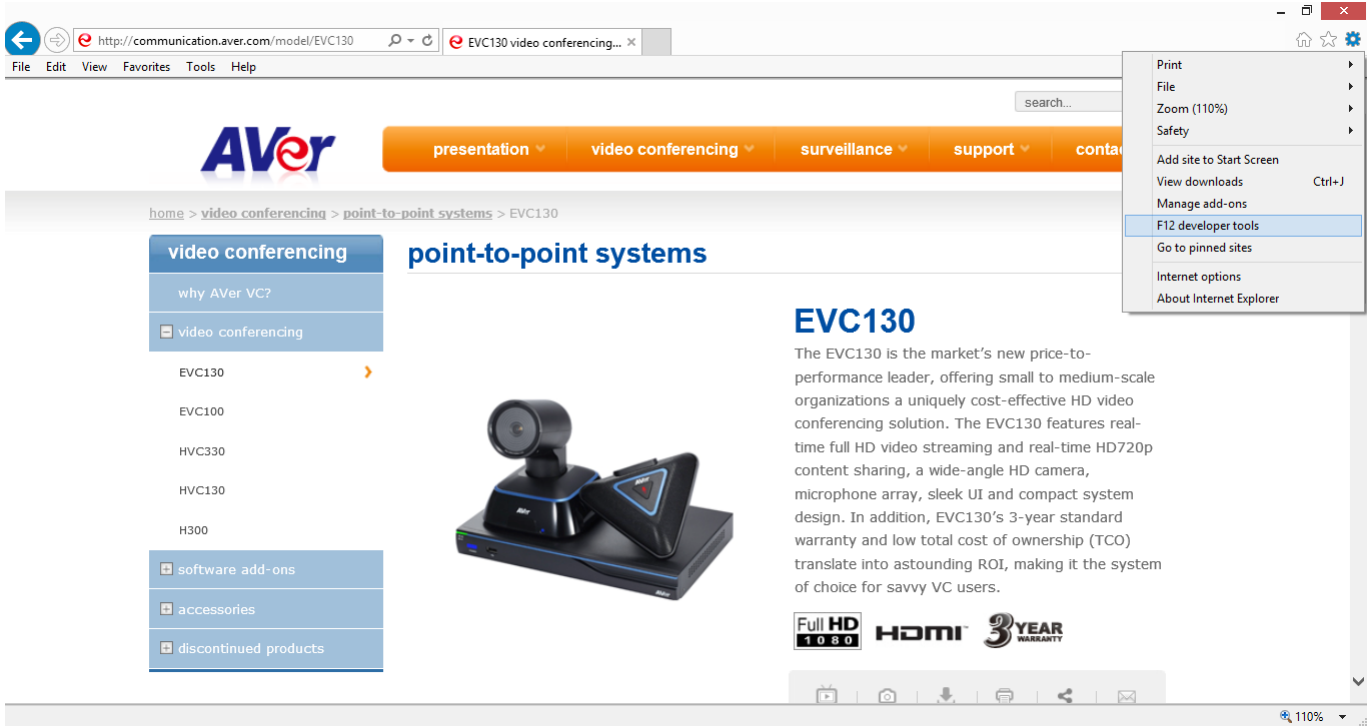

3. Change Document Mode to Internet Explorer 9 standards.

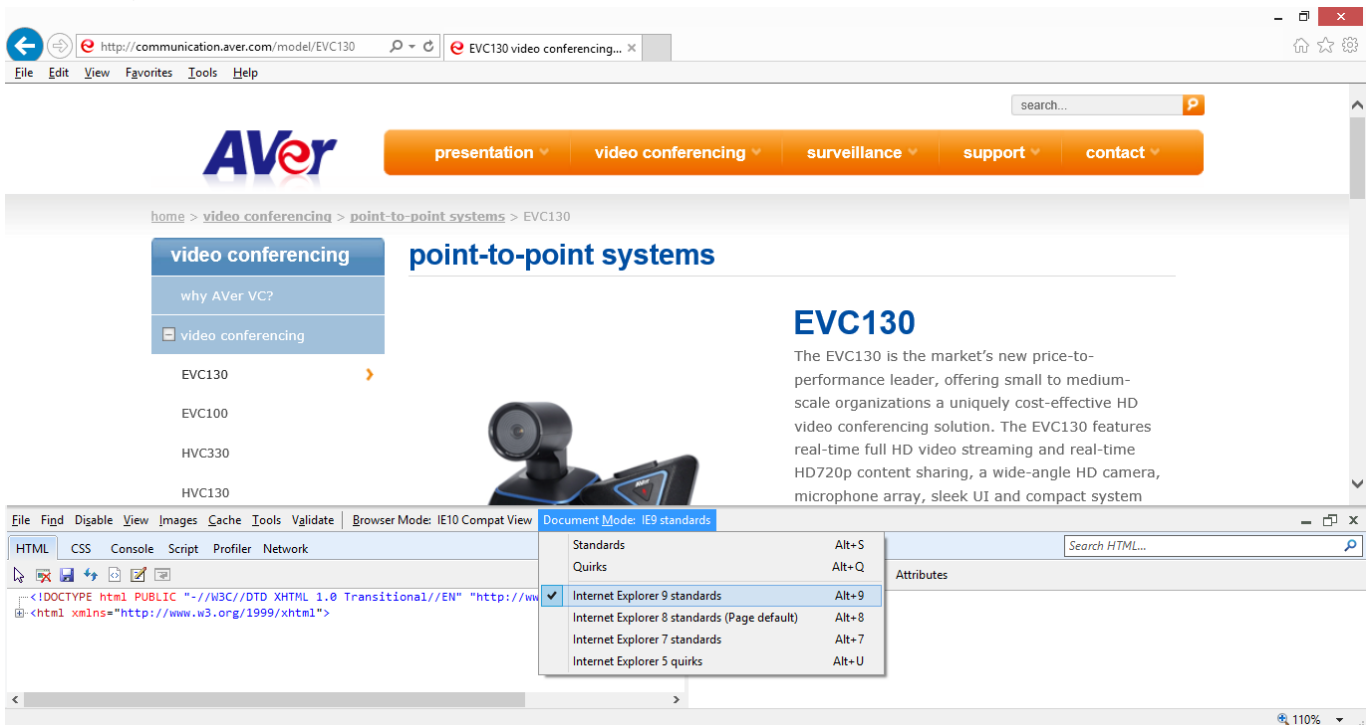

4. Disable intranet sites in Compatibility View. Go to “Tools | Compatibility view settings”.

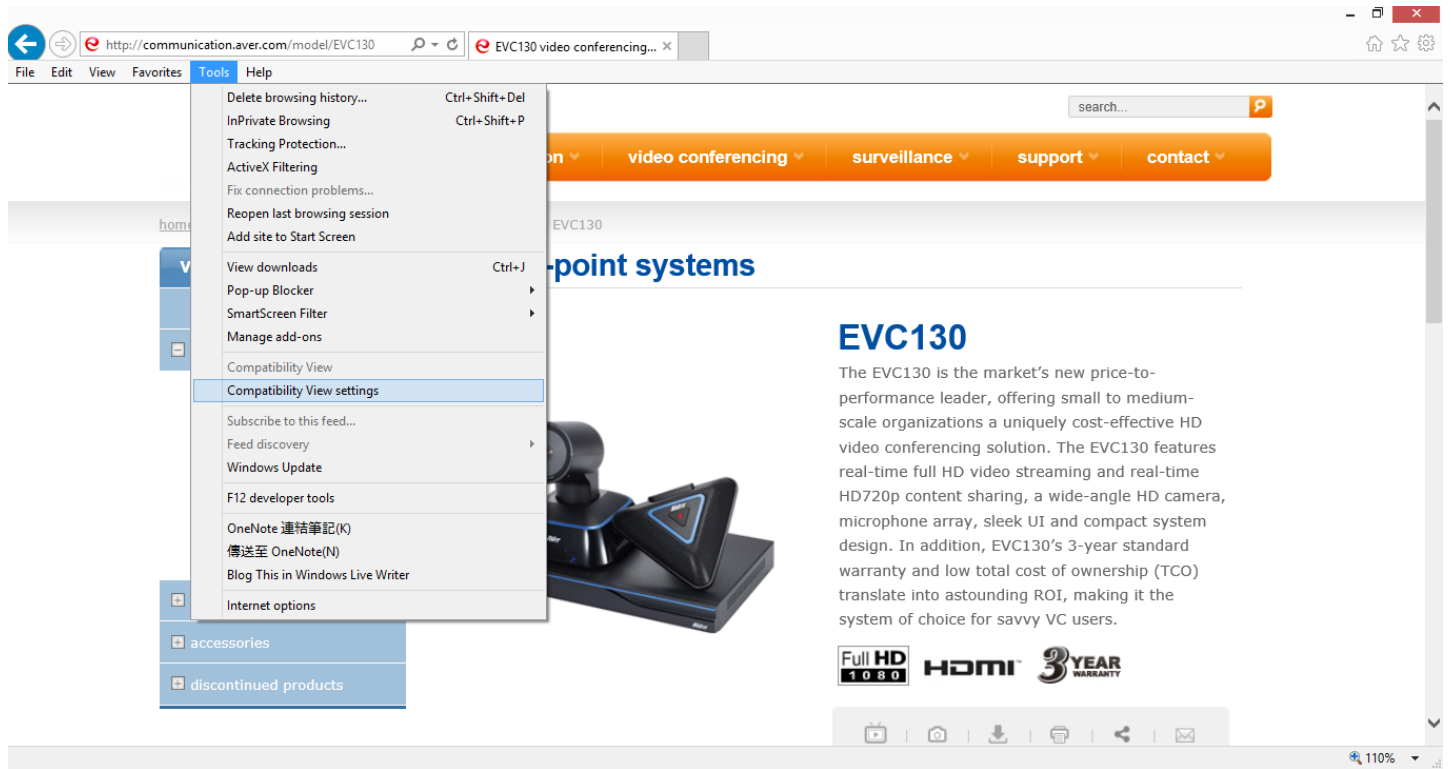

5. Unclick the checkbox “Display intranet sites in Compatibility View” and then click “Close”.

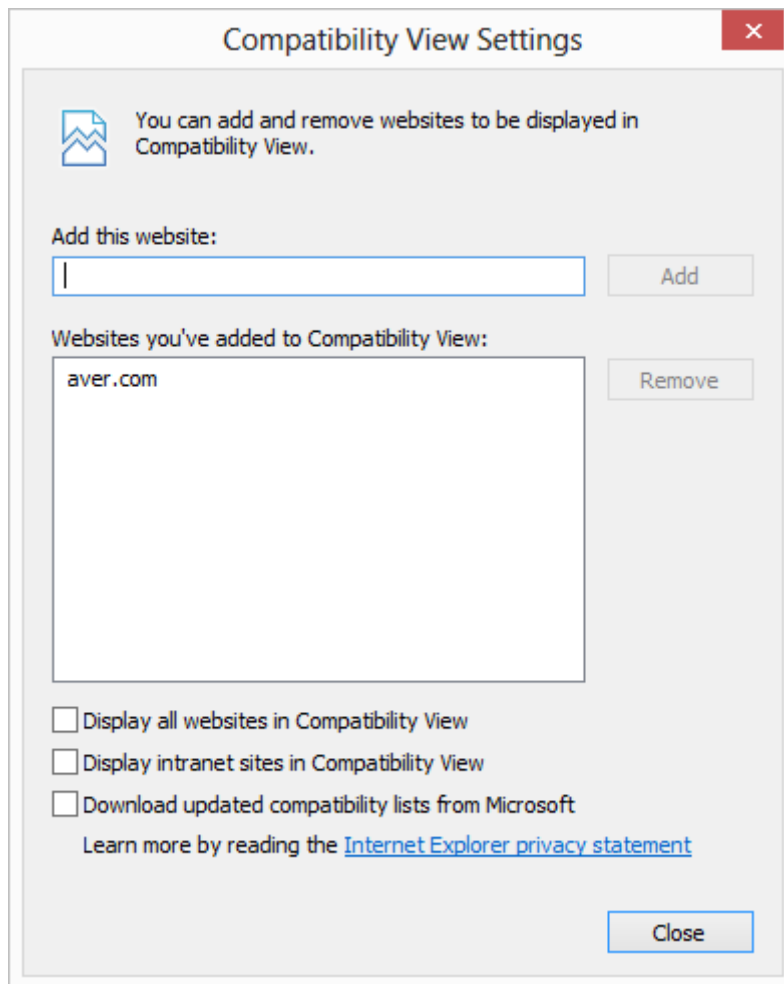

Others



Unable to connect the call and the “Call failed” error message appears on the screen.

- Ensure the IP address for the calling is correctly.
- Ensure the other end of your calling does not set their system to “Do Not Disturb” mode or pick up the phone.
- Ensure you are not calling to a system that has already up to maximum call-in limitation.

Forget the administrator password.

- Please contact AVer technical support for assistance.

Unable to control the far end camera.

- Make sure the “Cam Ctrl”  icon is positioned on the screen you want to control. Press “Far/Near”  button on the remote controller to switch to the desired screen.
- Make sure the far site has enabled the “Far End Camera Control” setting. To enable this function, press “Home”  button and got to General Setting | Administrator and then select “Far End Camera Control”.

AVer EVC cannot detect the USB device.

- Unplug and plug the USB flash drive again and wait for 10 to 15 seconds for the system to re-detect the new USB device.
- We do not recommend using an external HDD; it may cause system errors or recording failures.

Scenarios for LAN Connection

Public IP Configuration (Outside of Firewall)

Your EVC system is connecting directly to the internet.

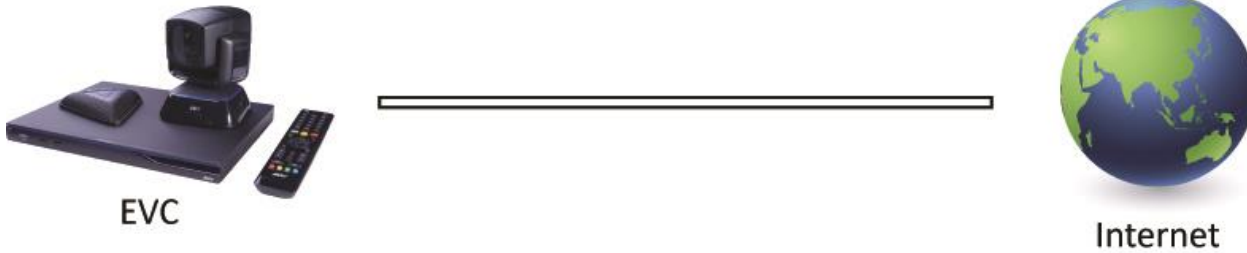

1. From the remote press “Home” -> “>” -> “Setting”.





2. Press “v” -> “Network”.

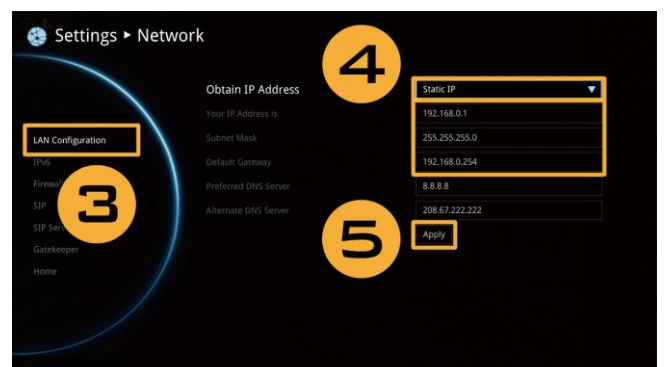

3. Press “LAN Configuration”.
 4. And In the drop-down list “Obtain IP address”, choose “Static IP” or “PPPoE”.
- **Static IP:** Input the “IP address”, “Subnet Mask” and “Default Gateway”.



Static IP setting

- **PPPoE:** Input the PPPoE login “User name” and “Password”.
- 5. Select “Apply” and press  (Enter).
- 6. Press “Home” on the remote to return to the home menu.
- 7. Press the  (Call) button on the remote and you are ready to make your first call.

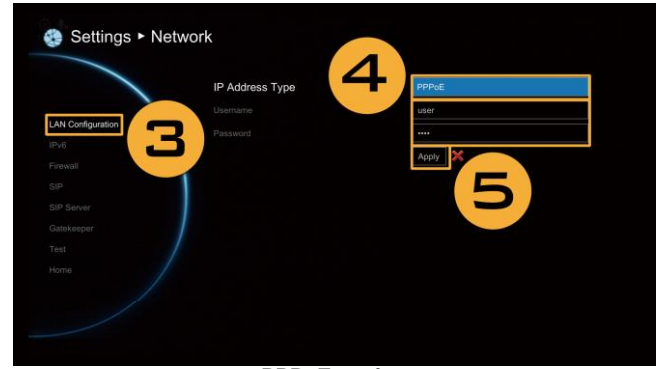

PPPoE setting

Private IP Configuration (Behind Firewall with Port Forwarding)

Please make sure you have set the following ports in port forwarding in your firewall.



Port	Function	Type
1719	Gatekeeper	UDP
1720	H.323 Call setup	TCP
30000~30299	Control and media for audio, video, content, and data/FECC	TCP and UDP
80	HTTP Interface (WebTool)	TCP
23	Telnet	TCP
5060	SIP	TCP and UDP

Your EVC system is connecting to the internet through a firewall.



1. From the remote press “Home”-> “>”->  “Setting”.







2. Press “” ->  “Network”.

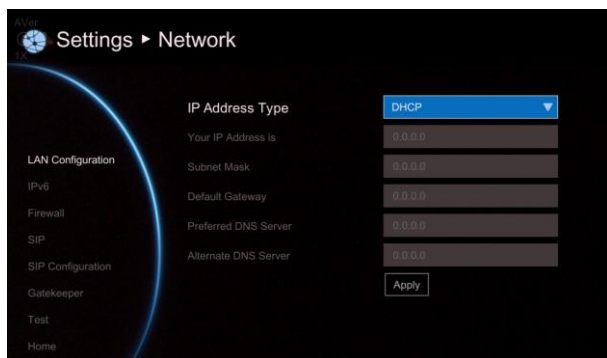
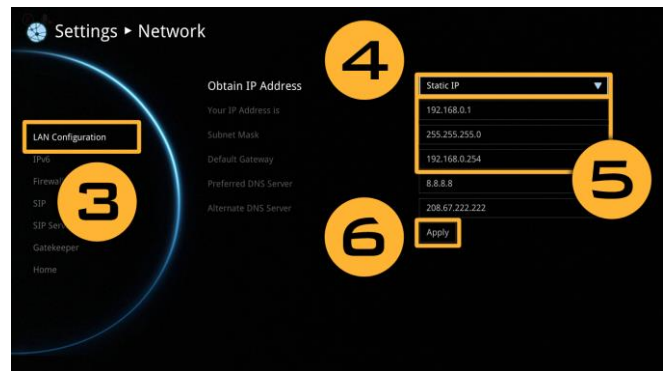

3. Press “LAN Configuration”.
4. And In the drop-down list “Obtain IP address”, choose “Static IP” or “DHCP”.
 - **Static IP:** Input the “IP address”, “Subnet Mask” and “Default Gateway”.
 - **DHCP:** Configure the system to automatically obtain an IP address from the DHCP server.



5. Select “Apply” and press  (Enter).
6. Press  (Back) on the remote to return to previous menu. (If you have H.323 ALG enabled, skip to step 10).

7. In the same page, go to “Firewall” and press  (Enter).
8. Select “ON” in the NAT check box and enter the IP address in the “NAT Public (WAN) address” field.
9. Press the “Home” button on the remote to return the home menu.
10. Press the  Call button on the remote and you are ready to make your first call.

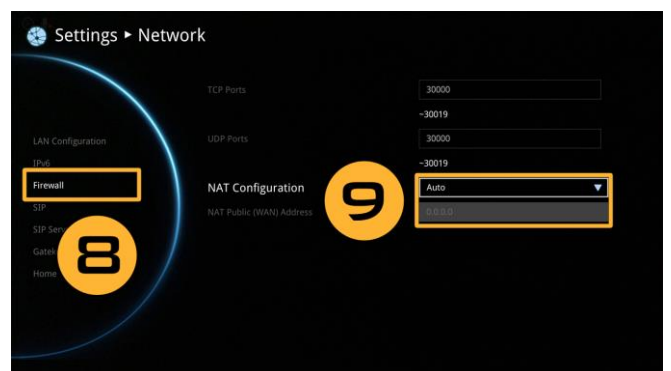

H.460 Gatekeeper with Firewall Traversal

Your EVC system is connecting to the internet through a firewall and you have a Gatekeeper outside the firewall.





1. From the remote press “Home” -> “>” ->  “Setting”.



2. Press “v” ->  “Network”.



3. Press “LAN Configuration (IPv4)”.
4. And In the drop-down list “Obtain IP address”, choose “Static IP”.
5. Manually input the “IP address”, “Subnet Mask” and “Default Gateway”.
6. Select “Apply” and press  (Enter).
7. In the same page, go to “Gatekeeper” and press  (Enter).

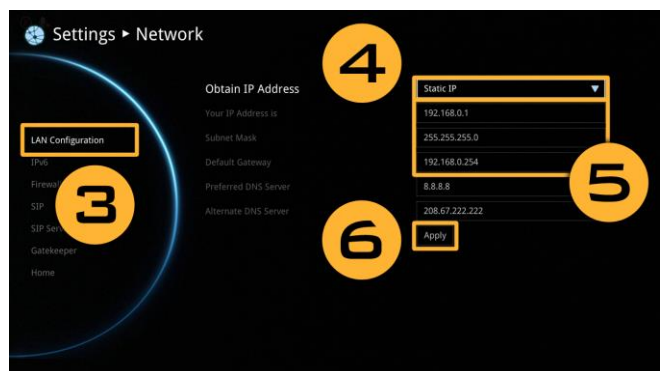

8. Enter the IP address of your Gatekeeper in the “Gatekeeper IP Address” field and enable the “Use Gatekeeper” check box.
9. Enable the “Enable H.460 firewall Traversal” option.
10. Press the “Home” button on the remote to return the home menu.
11. Press the  (Call) button on the remote and you are ready to make your first call.

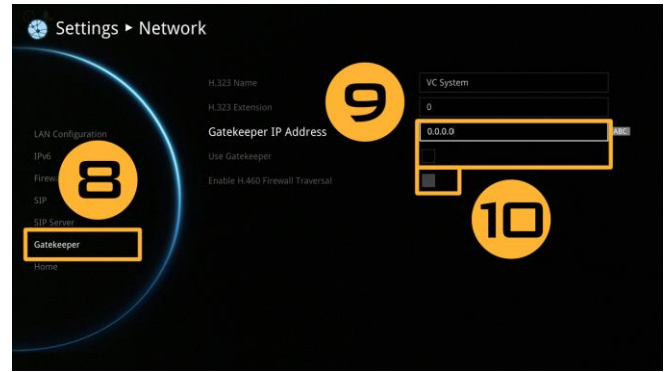

Remote Control Battery Safety Information

1. Store batteries in any cool & dry place.
2. Do not dispose used batteries in domestic waste. Dispose batteries at special collection points or return to stores if applies.
3. Remove the batteries if they are not in use for long period of time. Battery leakage and corrosion can damage the remote control, dispose batteries safely.
4. Do not mix and use old and new batteries.
5. Do not mix and use different types of batteries: alkaline, standard (carbon -zinc) or rechargeable (nickel-cadmium).
6. Do not dispose batteries in a fire.
7. Do not attempt to short circuit the battery terminals.

Limited Warranty

For a period of time beginning on the date of purchase of the applicable product and extending as set forth in the **“Warranty Period of AVer Product Purchased”** section of the warranty card, AVer Information Inc. (“AVer”) warrants that the applicable product (“Product”) substantially conforms to AVer’s documentation for the product and that its manufacture and components are free of defects in material and workmanship under normal use. “You” as used in this agreement means you individually or the business entity on whose behalf you use or install the product, as applicable. This limited warranty extends only to you as the original purchaser. Except for the foregoing, the Product is provided “AS IS.” In no event does AVer warrant that You will be able to operate the Product without problems or interruptions, or that the Product is suitable you’re your purposes. Your exclusive remedy and the entire liability of AVer under this paragraph shall be, at AVer’s option, the repair or replacement of the Product with the same or a comparable product. This warranty does not apply to (a) any Product on which the serial number has been defaced, modified, or removed, or (b) cartons, cases, batteries, cabinets, tapes, or accessories used with this product. This warranty does not apply to any Product that has suffered damage, deterioration or malfunction due to (a) accident, abuse, misuse, neglect, fire, water, lightning, or other acts of nature, commercial or industrial use, unauthorized product modification or failure to follow instructions included with the Product, (b) misapplication of service by someone other than the manufacturer’s representative, (c) any shipment damages (such claims must be made with the carrier), or (d) any other causes that do not relate to a Product defect. The Warranty Period of any repaired or replaced Product shall be the longer of (a) the original Warranty Period or (b) thirty (30) days from the date of delivery of the repaired or replaced product.

Limitations of Warranty

AVer makes no warranties to any third party. You are responsible for all claims, damages, settlements, expenses, and attorneys’ fees with respect to claims made against you as a result of your use or misuse of the Product. This warranty applies only if the Product is installed, operated, maintained, and used in accordance with AVer specifications. Specifically, the warranties do not extend to any failure caused by (i) accident, unusual physical, electrical, or electromagnetic stress, neglect or misuse, (ii) fluctuations in electrical power beyond AVer specifications, (iii) use of the Product with any accessories or options not furnished by AVer or its authorized agents, or (iv) installation, alteration, or repair of the Product by anyone other than AVer or its authorized agents.

Disclaimer of Warranty

Except as expressly provided otherwise herein and to the maximum extent permitted by applicable law, AVer disclaims all other warranties with respect to the product, whether express, implied, statutory or otherwise, including without limitation, satisfactory quality, course of dealing, trade usage or practice or the implied warranties of merchantability, fitness for a particular purpose or noninfringement of third party rights.

Limitation of Liability

In no event shall AVer be liable for indirect, incidental, special, exemplary, punitive, or consequential damages of any nature including, but not limited to, loss of profits, data, revenue, production, or use, business interruption, or procurement of substitute goods or services arising out of or in connection with this limited warranty, or the use or performance of any product, whether based on contract or tort, including negligence, or any other legal theory, even if AVer has advised of the possibility of such damages. AVer's total, aggregate liability for damages of any nature, regardless of form of action, shall in no event exceed the amount paid by you to AVer for the specific product upon which liability is based.

Governing Law and Your Rights

This warranty gives you specific legal rights; you may also have other rights granted under state law. These rights vary from state to state.

Federal Communications Commission Statement (Class A)

FC NOTE- This equipment has been tested and found to comply with the limits for a Class A digital device, pursuant to Part 15 of the FCC Rules. These limits are designed to provide reasonable protection against harmful interference in a residential installation. This equipment generates uses and can radiate radio frequency energy and, if not installed and used in accordance with the instructions, may cause harmful interference to radio communications. However, there is no guarantee that interference will not occur in a particular installation. If this equipment does cause harmful interference to radio or television reception, which can be determined by tuning the equipment off and on, the user is encouraged to try to correct the interference by one or more of the following measures:

Reorient or relocate the receiving antenna.

Increase the separation between the equipment and receiver.

Connect the equipment into an outlet on a circuit different from that to which the receiver is connected.

Consult the dealer or an experienced radio/television technician for help.

☞ For warranty period, please refer to the warranty card.

Class A ITE

Class A ITE is a category of all other ITE which satisfies the class A ITE limits but not the class B ITE limits. Such equipment should not be restricted in its sale but the following warning shall be included in the instructions for use:

Warning - This is a class A product. In a domestic environment this product may cause radio interference in which case the user may be required to take adequate measures.

CE Class A (EMC)

CE This product is herewith confirmed to comply with the requirements set out in the Council Directives on the Approximation of the laws of the Member States relating to Electromagnetic Compatibility Directive 2004/108/EC.

Warning - This is a Class A product. In a domestic environment this product may cause radio interference in which case the user may be required to take adequate measures to correct this interference.

Copyright

© 2015 by AVer Information Inc. All rights reserved. No part of this publication may be reproduced, transmitted, transcribed, stored in a retrieval system, or translated into any language in any form by any means without the written permission of AVer INFORMATION Inc.

Trademarks

AVer is registered trademarks of AVer Information Inc. Other trademarks used herein for description purpose only belong to each of their companies.

Disclaimer

No warranty or representation, either expressed or implied, is made with respect to the contents of this documentation, its quality, performance, merchantability, or fitness for a particular purpose. Information presented in this documentation has been carefully checked for reliability; however, no responsibility is assumed for inaccuracies. The information contained in this documentation is subject to change without notice. In no event will AVer be liable for direct, indirect, special, incidental, or consequential damages arising out of the use or inability to use this product or documentation, even if advised of the possibility of such damages.

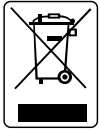

The mark of Crossed-out wheeled bin indicates that this product must not be disposed of with your other household waste. Instead, you need to dispose of the waste equipment by handing it over to a designated collection point for the recycling of waste electrical and electronic equipment. For more information about where to drop off your waste equipment for recycling, please contact your household waste disposal service or the shop where you purchased the product.

AVer Information Inc.
Website: <http://www.aver.com>

 **UniKomp.pl**
Nowe Technologie IT

adres	43-200 Pszczyna, ul. Piastowska 9
tel/fax	(32) 2102211, 3263300, 2128822
e-mail	sklep@unikomp.pl
internet	www.wyswietlanie.pl