

# CX-50

Model: C 5010S, R9861600D01C

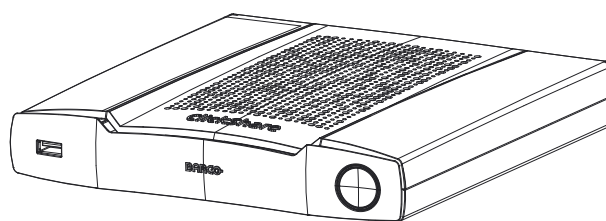

User guide

**BARCO**

**Gold partner**

**UniKomp**

Nowe Technologie IT

43-200 Pszczyna, ul. Dworcowa 8  
tel. (32) 210 22 11, 326 33 00  
barco@unikomp.pl  
www.unikomp.pl

**Barco NV**

Beneluxpark 21, 8500 Kortrijk, Belgium  
[www.barco.com/en/support](http://www.barco.com/en/support)  
[www.barco.com](http://www.barco.com)

**Registered office: Barco NV**

President Kennedypark 35, 8500 Kortrijk, Belgium  
[www.barco.com/en/support](http://www.barco.com/en/support)  
[www.barco.com](http://www.barco.com)

## Copyright ©

All rights reserved. No part of this document may be copied, reproduced or translated. It shall not otherwise be recorded, transmitted or stored in a retrieval system without the prior written consent of Barco.

## Trademarks

USB Type-C™ and USB-C™ are trademarks of USB Implementers Forum.

## Trademarks

Brand and product names mentioned in this manual may be trademarks, registered trademarks or copyrights of their respective holders. All brand and product names mentioned in this manual serve as comments or examples and are not to be understood as advertising for the products or their manufacturers.

## HDMI Trademark Notice



The terms HDMI, HDMI High Definition Multimedia Interface, and the HDMI Logo are trademarks or registered trademarks of HDMI Licensing Administrator, Inc.

## Product Security Incident Response

As a global technology leader, Barco is committed to deliver secure solutions and services to our customers, while protecting Barco's intellectual property. When product security concerns are received, the product security incident response process will be triggered immediately. To address specific security concerns or to report security issues with Barco products, please inform us via contact details mentioned on <https://www.barco.com/psirt>. To protect our customers, Barco does not publically disclose or confirm security vulnerabilities until Barco has conducted an analysis of the product and issued fixes and/or mitigations.

## Patent protection

This product is covered by patents and/or pending patent applications. For more info: <https://www.barco.com/en/about-barco/legal/patents>.

## Guarantee and Compensation

Barco provides a guarantee relating to perfect manufacturing as part of the legally stipulated terms of guarantee. On receipt, the purchaser must immediately inspect all delivered goods for damage incurred during transport, as well as for material and manufacturing faults Barco must be informed immediately in writing of any complaints.

The period of guarantee begins on the date of transfer of risks, in the case of special systems and software on the date of commissioning, at latest 30 days after the transfer of risks. In the event of justified notice of complaint, Barco can repair the fault or provide a replacement at its own discretion within an appropriate period. If this measure proves to be impossible or unsuccessful, the purchaser can demand a reduction in the purchase price or cancellation of the contract. All other claims, in particular those relating to compensation for direct or indirect damage, and also damage attributed to the operation of software as well as to other services provided by Barco, being a component of the system or independent service, will be deemed invalid provided the damage is not proven to be attributed to the absence of properties guaranteed in writing or due to the intent or gross negligence or part of Barco.

If the purchaser or a third party carries out modifications or repairs on goods delivered by Barco, or if the goods are handled incorrectly, in particular if the systems are operated incorrectly or if, after the transfer of risks, the goods are subject to influences not agreed upon in the contract, all guarantee claims of the purchaser will be rendered invalid. Not included in the guarantee coverage are system failures which are attributed to programs or special electronic circuitry provided by the purchaser, e.g. interfaces. Normal wear as well as normal maintenance are not subject to the guarantee provided by Barco either.

The environmental conditions as well as the servicing and maintenance regulations specified in this manual must be complied with by the customer.

## **Barco ClickShare Product Specific End User License Agreement<sup>1</sup>**

THIS PRODUCT SPECIFIC USER LICENSE AGREEMENT (EULA) TOGETHER WITH THE BARCO GENERAL EULA ATTACHED HERETO SET OUT THE TERMS OF USE OF THE SOFTWARE.

PLEASE READ THIS DOCUMENT CAREFULLY BEFORE OPENING OR DOWNLOADING AND USING THE SOFTWARE.

DO NOT ACCEPT THE LICENSE, AND DO NOT INSTALL, DOWNLOAD, ACCESS, OR OTHERWISE COPY OR USE ALL OR ANY PORTION OF THE SOFTWARE UNLESS YOU CAN AGREE WITH ITS TERMS AS SET OUT IN THIS LICENSE AGREEMENT.

### **1. Entitlement**

Barco ClickShare (the "Software") offered as a wireless presentation solution that includes the respective software components as further detailed in the applicable Documentation.

The Software can be used upon purchase from, and subject to payment of the relating purchase price to, a Barco authorized distributor or reseller of the ClickShare base unit and button or download of the authorized ClickShare applications (each a "Barco ClickShare Product").

- **Term**

The Software can be used under the terms of this EULA from the date of first use of the Barco ClickShare Product, for as long as you operate such Barco ClickShare Product.

- **Deployment and Use**

The Software shall be used solely in association with a Barco ClickShare Product in accordance with the Documentation issued by Barco for such Product.

### **2. Support**

The Software is subject to the warranty conditions outlined in the Barco warranty rider. Maintenance, including the provision of upgrades and updates to the Software, and helpdesk support are available at your option on the terms of Barco's then current warranty rider.

Higher maintenance and support levels can be obtained at the moment of product sale or during the Barco ClickShare Product and/or Software warranty term.

Higher maintenance and support levels may be included in the initial transaction if ordered and paid for additionally. It is strongly suggested to maintain the maintenance and support agreement without interruption. Barco reserves the right not to restart maintenance following an interruption by the customer.

### **3. Terms of Use**

The Software can be used as set out in the Barco EULA attached hereto.

The provisions of this Product Specific EULA override the Barco generic EULA in case of conflicts or inconsistencies.

In case of (inadvertent or other) non-compliance (e.g. where the actual use overshoots the use authorized hereunder), Barco shall have the option to suspend access to the Software until the non-compliance is remedied, failing of which Barco may terminate the License Agreement as set out herein.

### **4. Privacy**

You are controller for personal data which are being processed via the Software. Therefore, you remain solely responsible for complying with all applicable data protection laws and for implementing and maintaining privacy protection and security measures (especially for components that you provide or control). Barco disclaims any liability in this regard.

Barco created a specific privacy policy for the ClickShare software application for mobile devices, which describes the processing of personal data via this application (<http://www.barco.com/en/about-barco/legal/privacy-policy/clickshare-app>).

### **5. Other Terms**

- **Open Source components**

The Software contains software components released under an Open Source license.

A list of the third party components used is available in the Software's README files, through the "My Barco" section of the Barco website or through other (online) means. The applicable license terms,

---

1: In the event of any differences or inconsistencies between translations of the EULA and the English text of the EULA, the English text will prevail.

copyright notices and, as relevant, source code access conditions apply as set out in the Barco EULA attached hereto.

- **Retention of data**

Barco right to use and retain Functional Information (section 10.2 of the EULA) shall survive the term of this EULA.

## **BARCO END USER LICENSE AGREEMENT<sup>1</sup>**

By accepting these terms (through tick box or other mechanism designed to acknowledge agreement to the terms of an electronic copy of this License Agreement), or by installing, downloading, accessing, or otherwise copying or using all or any portion of the Software (as defined below), (i) you accept this License Agreement on behalf of the entity for which you are authorized to act (e.g., your employer) and you agree to act in a manner consistent with this License Agreement (or, if there is no such entity for which you are authorized to act, you accept this License Agreement on behalf of yourself as an individual and acknowledge that you are legally bound by this Agreement), and (ii) you represent and warrant that you are duly empowered by the end user in case you act on behalf of such entity.

These terms apply to your use of the Software as of and for the original Term of your license. When you renew or purchase an additional license, the then current version of this License Agreement shall apply and will remain unchanged during the term of that license and/or in respect of such changed elements. The other contract documents (Product Specific EULA; Maintenance and Support Agreement, if and when provided alongside with this document) applies in addition to these terms and constitute the entire License Agreement. You acknowledge that an electronic copy of this Agreement shall have the same proving value as a hard copy signed by the parties.

If you are unwilling to accept this License Agreement on these terms, or you do not have the right, power and authority to act on behalf of and bind such entity (or yourself as an individual if there is no such entity), DO NOT SELECT THE "I ACCEPT" BUTTON OR OTHERWISE CLICK ON ANY BUTTON OR OTHER MECHANISM DESIGNED TO ACKNOWLEDGE AGREEMENT, AND DO NOT INSTALL, DOWNLOAD, ACCESS, OR OTHERWISE COPY OR USE ALL OR ANY PORTION OF THE SOFTWARE.

### **1. Definitions**

"Affiliate" means any corporation or other entity directly or indirectly, controlling, controlled by or under common control with such corporation or entity. For the purpose of the above, "control" shall mean (i) the ownership or control, directly or indirectly, of fifty percent (50%) or more of the equity capital or the shares or voting rights in the corporation or other entity in question or (ii) the control of the composition of the board of directors of the corporation or other entity in question.

"Barco" means Barco NV (company number 0473.191.041) with company address at Beneluxpark 21, 8500 Kortrijk, Belgium, or its designated Affiliate licensing to you the proprietary software which is the subject matter of this Agreement.

"Documentation" means all technical, reference and installation manuals, user guides, published performance specifications and other written documentation provided by Barco generally to its licensees with respect to the Software, along with any modifications and updates thereto;

"DRM" means Barco's digital rights management platform used to provide access to and access conditions of the Software.

"License Agreement" means this Barco End User License Agreement (EULA), incorporating the terms of the Product Specific EULA, and any modifications thereof as set out herein.

"Product Specific EULA" means the supplemental software terms applicable

"Software" means the computer software, released in object code only, which is being licensed hereunder, as described in the applicable purchase order and related Product Specific EULA.

"Term" means the period set out in article 9.1 hereof, as well as any agreed renewal period.

"you" means the entity on behalf of which these terms are accepted, and any of its representatives having access to the Software.

### **2. License Grant**

2.1 '*License Scope*'. Subject to compliance with all license terms and payment of applicable fees, Barco grants you a limited, non-exclusive, non-assignable, non-transferable, non-sub-licensable license to use the Software exclusively in accordance with the conditions and parameters set forth herein. Save for the Product Specific EULA or any broader license terms confirmed through the DRM tool, the license under this License Agreement applies to one (1) copy of the Software to be used on one single computing device by one (1)

single user. Installation on a computing device that may be concurrently accessed by more than one user shall not constitute a permitted use and a separate license is required for each user connecting at the same time to a computing device on which the Software is being deployed.

2.2 '*License Type*'. The applicable license type, and your rights in time, deployment and usage, are further detailed in the Product Specific EULA (in the absence of which the scope shall be as set in article 2.1 hereof).

2.3 '*License restrictions*'.

*Intended Use*. You agree to use the Software solely as permitted by this License Agreement (and any Product Specific EULA made part of it), by any applicable laws and in a matter consistent with its design and Documentation.

*No Transfer (License Agreement)*. You agree not to transfer, assign or sublicense your license rights to any other person or entity, unless Barco's prior written consent is obtained.

*No Transfer (Software)*. If you deactivate or uninstall the Software from the computer device on which it was originally installed, this will terminate this License Agreement unless otherwise and specifically approved by Barco. You agree not to use the Software in association with other hardware or software that allows to pool connections, reroute information or in any other way enables to breach or circumvent the license restrictions by enabling the deployment and use of the Software by more than the authorized number of devices or users (e.g. multiplexing) or otherwise attempts to reduce the number of licenses actually required.

*Authorized Users*. The use of the Software is restricted to persons within your organization, or any third party representatives operating under your responsibility and control, provided any such persons have accepted the terms of this License Agreement. You agree not to use or permit the Software to be used to perform services for third parties, whether on a service bureau or time sharing basis or otherwise, without the prior written authorization of Barco. You shall not lease, rent, sell or otherwise transfer or grant a security or other interest in the Software.

*No Modifications*. You shall not make error corrections to or otherwise modify or adapt the Software or create derivative works based upon the Software, or permit third parties to do the same.

*No Reverse Engineering*. You agree not to reverse engineer or decompile, decrypt, disassemble or otherwise reduce the Software to human-readable form, except to the extent otherwise expressly permitted under applicable law notwithstanding this restriction, or except to the extent Barco is legally required to permit such specific activity pursuant to any applicable open source license.

*Code required to ensure interoperability*. To the extent required by law, and at your written request, Barco shall provide you with the interface information needed to achieve interoperability between the Software and another independently created programs used by you, on payment of Barco's applicable fee (if any). You shall observe strict obligations of confidentiality with respect to such information and shall use such information in compliance with terms and conditions which Barco makes applicable.

*No Unbundling*. The Software may include various applications and components, may support multiple platforms and languages, and may be provided on multiple media or in multiple copies. Nonetheless, the Software is designed and provided to you as a single product to be used as a single product on devices as permitted herein. You agree not to unbundle the component parts of the Software for use on different computer devices.

*Territory*. You agree to use the Software solely in the territory or region where you obtained the Software from Barco or its authorized reseller or as otherwise stated in the Documentation. Any export if permitted shall comply with any applicable (export) laws and regulations.

2.4 '*Your Infrastructure*'. You remain responsible to procure and maintain hardware, operating system, network and other infrastructure (the "Infrastructure") required to operate the Software and to keep such Infrastructure functioning and virus-free. You acknowledge that the Software is a complex computer software application, and that the performance thereof may vary depending hardware platform, software interactions and configuration. You acknowledge that the Software is not designed and produced specifically to meet your requirements and expectations and the selection of the Software by you is entirely your own choice and decision.

### **3. Ownership. Intellectual Property Rights.**

3.1 '*Ownership*'. Any Software is licensed, not sold to you, on a non-exclusive basis for use only under the terms of this License Agreement, and Barco and its suppliers reserve all rights not expressly granted to you. You may own the carrier on which the Software is provided, but the Software is owned and copyrighted by Barco or by third party suppliers. Your license confers no title or ownership and is not a sale of any rights in the Software or its Documentation.

3.2 *'Third Party Materials'*. The Software may contain or require the use of certain third party technology (whether proprietary or open source software), identified by Barco in the Documentation, readme file, third-party click-accept, on [www.barco.com](http://www.barco.com) or elsewhere (the "Identified Components"). Identified Components may be subject to additional and/or different terms and you agree that the Identified Components are licensed under the terms, disclaimers and warranties of their respective licenses which in the forthcoming case shall override the provisions of this License Agreement.

3.3 *'Source Code Access'*. To the extent required under third party (open source) license terms, and for a period of 36 months following your acceptance of this License Agreement, Barco shall provide access to the source code controlled by a third party (open source) license, via email or download link. If the relevant license terms require so, you may require Barco (attn. its legal department, at the address stated above) to obtain such code on tangible medium against payment of the cost of media, shipping and handling.

3.4 *'Trademarks / Copyright'*. Any brand and product names mentioned in relation to the Software may be trademarks, registered trademarks or copyrights of their respective (third party) holders. In addition, the Software is protected by national and international laws and treaty provisions. Copyright on the Software components belongs to the respective initial copyright holder, each additional contributor and/or their respective assignee(s), as may be identified in the Software Documentation, source code, README file, or otherwise. You shall not remove or obscure or otherwise alter any trademark, copyright or other proprietary notices, legends or logo's placed on or contained within the Software.

3.5 *'Trade Secrets'*. You acknowledge that the Software embodies valuable trade secrets of Barco and its third party licensors and agree not to disclose, provide or otherwise make available such trade secrets contained within the Software and Documentation in any form to any third party without the prior written consent of Barco. You shall implement all reasonable security measures to protect such trade secrets.

#### **4. Support**

4.1 *'Principle'*. Barco is under no obligation to provide support and maintenance in respect of the Software, except as included in a Product Specific EULA and/or to the extent you have entered into a separate maintenance and support agreement and paid applicable maintenance and support fees. Any unauthorized use of the Software, as specified in any maintenance and support agreement, may prohibit Barco from providing such support and maintenance.

4.2 *'Support policy'*. Maintenance releases updates or upgrades can be obtained under the terms of a separate maintenance and support agreement which is being offered to you. Such agreements, together with the support included in a Product Specific EULA, include Barco's sole liability and your sole remedy in respect of the support and maintenance of the Software. You agree to install any maintenance releases to address bugs or security issues in the Software if the same are being provided to you. Barco will keep you informed as of when earlier versions of the Software are no longer serviced.

4.3 *'Remote connectivity'*. Barco may require, as a material condition to provide maintenance or support, that the Software remains remotely connected with Barco over a network.

#### **5. Warranty**

EXCEPT FOR THE LIMITED WARRANTY THAT MAY APPLY AS PER THE PRODUCT SPECIFIC EULA, YOU UNDERSTAND THAT THE SOFTWARE IS BEING PROVIDED TO YOU "AS IS". BARCO DOES NOT MAKE NOR INTENDS TO MAKE ANY WARRANTIES OR REPRESENTATIONS, EXPRESS OR IMPLIED AND SPECIFICALLY DISCLAIMS ALL IMPLIED WARRANTIES OF MERCHANTABILITY, FITNESS FOR A PARTICULAR PURPOSE AND NON-INFRINGEMENT OF INTELLECTUAL PROPERTY AND DOES NOT WARRANT THAT THE SOFTWARE WILL BE FREE FROM ERRORS OR THAT YOU WILL BE ABLE TO OPERATE THE SOFTWARE WITHOUT INTERRUPTIONS OR THAT SUCH ERRORS WILL BE CORRECTED BY BARCO. EXCEPT FOR ANY MAINTENANCE AND SUPPORT OBLIGATIONS SEPARATELY AGREED, YOU ARE SOLELY RESPONSIBLE FOR ALL COSTS AND EXPENSES ASSOCIATED WITH RECTIFICATION, REPAIR OR DAMAGE CAUSED BY SUCH ERRORS. IN THE FORTHCOMING CASE, THE WARRANTY DISCLAIMER FOUND IN APPLICABLE OPEN SOURCE LICENSES SHALL OVERRIDE THE PROVISIONS OF THIS LICENSE AGREEMENT.

#### **6. Compliance and Enforcement**

6.1 *'Reporting and Audit'*. In addition to good practice record-keeping obligations, you agree to report the use of the Software and relating billing metrics in the DRM or otherwise as agreed. You grant to Barco and its designated auditors, at Barco's expenses, the right to verify your deployment and use of the Software during your normal business hours so as to verify your compliance with the License Agreement. In the event such audit reveals non-compliance with your payment obligations hereunder, you shall promptly pay to Barco the appropriate license fees plus the reasonable cost of conducting the audit.

6.2 *'Fair Use Monitor'*. You are informed and acknowledge that the Software includes technology which allows to remotely decrease (in part or in full) the functionality of the Software (the "Fair Use Monitor"). Such technology is an enabling tool and a material condition precedent for Barco to enter into this License Agreement.

6.3 *'Enforcement'*. Upon breach of the License Agreement (including overdue payment), Barco shall inform the then known user, through the DRM or otherwise in writing, (i) which condition of the License Agreement (including payment terms) is violated; (ii) allow a period of 8 calendar days to cure such breach, if it can be cured at all; and (iii) inform which part of the functionality Barco intends to reduce (all Software or certain additionally licensed features only; in part or in full) if the breach is not remedied on time and in full.

6.4 *'Remedy'*. If the breach is not cured within the applicable remedy period (or cannot be cured at all), Barco shall have the option (i) to cause you to procure such additional licenses required as per the actual usage; (ii) to reduce the Software's functionality, including through the use of the Fair Use Monitor; or (iii) to terminate the License Agreement as set out herein, without prejudice to any other remedies available at law, under contract or in equity.

6.5 *'Indemnification'*. YOU HEREBY AGREE TO INDEMNIFY, DEFEND AND HOLD HARMLESS BARCO AND BARCO'S AFFILIATES FROM AND AGAINST ANY AND ALL ACTIONS, PROCEEDINGS, LIABILITY, LOSS, DAMAGES, FEES AND COSTS (INCLUDING ATTORNEY FEES), AND OTHER EXPENSES INCURRED OR SUFFERED BY BARCO ARISING OUT OF OR IN CONNECTION WITH ANY BREACH BY YOU OF THE TERMS OF THIS SOFTWARE LICENSE.

## **7. Limitation of Liability**

TO THE MAXIMUM EXTENT PERMITTED BY LAW, BARCO ACCEPTS NO LIABILITY FOR ANY DAMAGES, LOSSES OR CLAIMS YOU OR ANY THIRD PARTY MAY SUFFER AS A RESULT OF YOUR USE OF THE SOFTWARE. IN JURISDICTIONS WHERE BARCO'S LIABILITY CANNOT BE EXCLUDED, BARCO'S LIABILITY FOR DIRECT DAMAGES SHALL BE LIMITED TO THE LICENSE FEES ACTUALLY PAID FOR THE SOFTWARE DURING THE TWELVE MONTHS PRECEDING THE CLAIM (OR AN AMOUNT OF 250 EURO IF NO FEE WOULD BE PAID) IN THE AGREGATE.

TO THE MAXIMUM EXTENT PERMITTED BY LAW, IN NO EVENT WILL BARCO BE LIABLE FOR ANY INDIRECT, SPECIAL, PUNITIVE, INCIDENTAL OR CONSEQUENTIAL LOSS OR DAMAGES OF ANY KIND WHICH MAY ARISE OUT OF OR IN CONNECTION WITH THE SOFTWARE, THIS SOFTWARE LICENSE OR THE PERFORMANCE OR PURPORTED PERFORMANCE OF OR FAILURE IN THE PERFORMANCE OF BARCO'S OBLIGATIONS UNDER THIS SOFTWARE LICENSE OR FOR ANY ECONOMIC LOSS, LOSS OF BUSINESS, CONTRACTS, DATA, GOODWILL, PROFITS, TURNOVER, REVENUE, REPUTATION OR ANY LOSS ARISING FROM WORK STOPPAGE, COMPUTER FAILURE OR MALFUNCTION OF THE SOFTWARE AND ANY AND ALL OTHER COMMERCIAL DAMAGES OR LOSSES WHICH MAY ARISE IN RESPECT OF USE OF THE SOFTWARE, EVEN IF BARCO HAS BEEN ADVISED OF THE POSSIBILITY OF THEIR OCCURRENCE.

## **8. Confidentiality**

8.1 *'Confidential Information'*. You will be receiving information which is proprietary and confidential to Barco during the procurement and Term of this License Agreement. "Confidential Information" shall include (i) the underlying logic, source code and concepts of the Software or other trade secrets (the access to which is strictly limited as expressly set out herein), (ii) any information designated as confidential by Barco or which has the necessary quality of confidence about it and (iii) any license key provided by Barco to you hereunder.

8.2 *'Non-Disclosure'*. You agree not to divulge any Confidential Information to any persons without Barco's prior written consent provided that this article 8 shall not extend to information which was rightfully in your possession prior to the commencement of this License Agreement, which is already public knowledge or becomes so at a future date (otherwise than as a result of a breach of this article 8), to the extent it is required to be disclosed by law or which is trivial or obvious. You agree not to use any Confidential Information except for the authorized purpose hereunder. The foregoing obligations as to confidentiality shall survive the Term of this License Agreement.

## **9. Term and Termination**

9.1 *'Term'*. The duration of this License Agreement will be from the date of your acceptance (as set forth above) of the Software (whereby you acknowledge that use of the Software implies acceptance), until you deactivate the Software, discontinue the use of the device on which the Software was first installed for its intended use or the expiration of the limited time period set out in the Product Specific EULA, whichever comes first.

9.2 *'Termination'*. You may terminate this License Agreement at any time by destroying all copies of the Software then in your possession and destroying all Documentation and associated materials, or returning the



same to Barco or the appointed Barco reseller that sold or provided these to you. Barco may terminate this License Agreement, immediately or gradually in accordance with article 6 hereof, by informing you at any time if any user is in breach of any of the License Agreement's terms.

9.3 '*Consequences of Termination*'. All rights associated with the use of the Software and the acquisition of updates and upgrades cease once the License Agreement is terminated or expires. Termination or expiry of your license will not entitle you to any retroactive refund of current or past payments.

## **10. Other relevant terms**

10.1 '*Personal Data*'. Whether or not Barco assumes the role of processor of personal data (as stated in the Product Specific EULA), you remain solely responsible for complying with all applicable data protection laws and for implementing and maintaining privacy protection and security measures (especially for components that you provide or control). Barco disclaims any liability for any data not provided by Barco, or any use of the Software outside the intended use as per this License Agreement or an applicable data processing annex.

10.2 '*Functional Information*'. Via the Software, Barco may gather technical information about (i) the functioning and the functionality of the products which are connected through the Software, and/or (ii) as provided by you or generated by your use of the Software ("Functional Information"). Barco may make use of such Functional Information for purposes of analytics, for developing and improving products and services, offering products and services to your organization and/or allowing third parties to access such Functional Information; based on the legitimate interest of Barco of evaluating the market, assessing and improving its products and conducting research and development. All knowhow, inventions and works derived by Barco from the Functional Information will be exclusively owned by Barco.

## **11. Final Clauses**

11.1 '*Entire Agreement*'. This License Agreement is the only understanding and agreement between you and Barco for use of the Software. This License Agreement supersedes all other communications, understandings or agreements we had prior to this License Agreement (with the exception of any continuing confidentiality agreement).

11.2 '*Notices*'. Notices can be validly delivered through the DRM and alternatively or additionally to the parties' last known address.

11.3 '*Severability*'. This License Agreement shall not be altered, amended or varied, except by written agreement signed by its parties. If any provision of this License Agreement is determined to be illegal, void or unenforceable, or if any court of competent jurisdiction in any final decision so determines, this License Agreement shall continue in full force save that such provision shall be deemed to be deleted with effect from the date of such decision, or such earlier date, and shall be replaced by a provision which is acceptable by law and which embodies the intention of this License Agreement as close as possible.

11.4 '*Export*'. You acknowledge that this Software may be subject to U.S. or other governments' Export control laws and regulations. You agree to comply with all applicable international and national laws that apply to the Software, including the U.S. Export Administration Regulations, as well as end-user, end-use, and destination restrictions issued by the U.S. or other governments.

11.5 '*Survival*'. The provisions of articles 3, 5, 6, 7, 8, 10 and 11 will survive the termination of this License Agreement, howsoever caused, but this will not imply or create any continued right to use the Software after termination of this License Agreement.

11.6 '*Assignment*'. You are not allowed to assign this Agreement in part or in full to any third party without Barco's consent. Barco shall be entitled to assign all or any of Barco's obligations hereunder to a third party and/or any of Barco's Affiliates.

11.7 '*Law and Jurisdiction*'. The construction, validity and performance of this License Agreement shall be governed in all respects by the laws of Belgium, without recourse to its conflict of law principles. All disputes arising in any way out of or affecting this License Agreement shall be subject to the exclusive jurisdiction of the courts of Kortrijk (Belgium), without prejudice to enforcement of any judgment or order thereof in any other jurisdiction. The United Nations Convention on Contracts for the International Sale of Goods (the "Convention") shall not apply to this License Agreement, however, if the Convention is deemed by a court of competent jurisdiction to apply to this License Agreement, Barco shall not be liable for any claimed non-conformance of the Software under Article 35(2) of the Convention.

**YOU HEREBY ACKNOWLEDGE TO HAVE READ, UNDERSTOOD AND ACCEPTED TO BE BOUND BY ALL THE TERMS AND CONDITIONS OF THIS LICENCE AGREEMENT AS INDICATED ABOVE**

## Barco ClickShare Product Specific Privacy policy

You are controller for personal data which are being processed via the Software. Therefore, you remain solely responsible for complying with all applicable data protection laws and for implementing and maintaining privacy protection and security measures (especially for components that you provide or control). Barco disclaims any liability in this regard. Barco created a specific privacy policy for the ClickShare software application for mobile devices, which describes the processing of personal data via this application (<http://www.barco.com/en/about-barco/legal/privacy-policy/clickshare-app>).

Via the Software, Barco may gather technical information about (i) the functioning and the functionality of the products which are connected through the Software, and/or (ii) as provided by you or generated by your use of the Software ("Functional Information"). Barco may make use of such Functional Information for purposes of analytics, for developing and improving products and services, offering products and services to your organization and/or allowing third parties to access such Functional Information; based on the legitimate interest of Barco of evaluating the market, assessing and improving its products and conducting research and development. All knowhow, inventions and works derived by Barco from the Functional Information will be exclusively owned by Barco.

## Open Source Software provisions

This product contains software components released under an Open Source license. A copy of the source code is available on request by contacting your Barco customer support representative.

EACH SEPARATE OPEN SOURCE SOFTWARE COMPONENT AND ANY RELATED DOCUMENTATION ARE PROVIDED "AS IS" WITHOUT EXPRESS OR IMPLIED WARRANTY INCLUDING, BUT NOT LIMITED TO, THE IMPLIED WARRANTIES OF MERCHANTABILITY AND FITNESS FOR A PARTICULAR PURPOSE. IN NO EVENT SHALL THE COPYRIGHTHOLDER OR ANY OTHER CONTRIBUTOR BE LIABLE FOR DIRECT, INCIDENTAL, SPECIAL, EXEMPLARY OR CONSEQUENTIAL DAMAGES, EVEN IF ADVISED OF THE POSSIBILITY OF SUCH DAMAGES, HOWEVER CAUSED AND ON ANY THEORY OF LIABILITY, WHETHER IN CONTRACT, STRICT LIABILITY, OR TORT (INCLUDING NEGLIGENCE OR OTHERWISE) ARISING IN ANY WAY OUT OF THE USE OF THIS OPEN SOURCE SOFTWARE. MORE INFORMATION/ DETAILS IS TO BE FOUND IN EACH SPECIFIC OPEN SOURCE LICENSE.

Copyright on each Open Source Software component belongs to the respective initial copyright holder, each additional contributor and/or their respective assignee (s), as may be identified in the respective documentation, source code, README file, or otherwise. You shall not remove or obscure or otherwise alter the respective copyrights.

You acknowledge living up to the conditions of each separate Open Source Software license.

In the development of the Software, the following Open Source Software components have been used:

PACKAGE	VERSION	SOURCE SITE
alsa-lib	1.1.7	<a href="ftp://ftp.alsa-project.org/pub/lib">ftp://ftp.alsa-project.org/pub/lib</a>
alsa-utils	1.1.7	<a href="ftp://ftp.alsa-project.org/pub/utils">ftp://ftp.alsa-project.org/pub/utils</a>
libsamplerate	0.1.9	<a href="http://www.mega-nerd.com/SRC">http://www.mega-nerd.com/SRC</a>
libsndfile	1.0.28	<a href="http://www.mega-nerd.com/libsndfile/files">http://www.mega-nerd.com/libsndfile/files</a>
ncurses	6.1	<a href="http://ftpmirror.gnu.org/ncurses">http://ftpmirror.gnu.org/ncurses</a>
avahi	0.7	<a href="https://github.com/lathiat/avahi/releases/download/v0.7">https://github.com/lathiat/avahi/releases/download/v0.7</a>
dbus	1.12.16	<a href="https://dbus.freedesktop.org/releases/dbus">https://dbus.freedesktop.org/releases/dbus</a>
expat	2.2.7	<a href="http://downloads.sourceforge.net/project/expat/expat/2.2.7">http://downloads.sourceforge.net/project/expat/expat/2.2.7</a>
libselenium	2.8	<a href="https://raw.githubusercontent.com/wiki/SELinuxProject/selinux/files/releases/20180524">https://raw.githubusercontent.com/wiki/SELinuxProject/selinux/files/releases/20180524</a>
libsepol	2.8	<a href="https://raw.githubusercontent.com/wiki/SELinuxProject/selinux/files/releases/20180524">https://raw.githubusercontent.com/wiki/SELinuxProject/selinux/files/releases/20180524</a>
pcre	8.42	<a href="https://ftp.pcre.org/pub/pcre">https://ftp.pcre.org/pub/pcre</a>
python3	3.7.4	<a href="https://python.org/ftp/python/3.7.4">https://python.org/ftp/python/3.7.4</a>

<b>PACKAGE</b>	<b>VERSION</b>	<b>SOURCE SITE</b>
bluez5_utils-headers	5.50	<a href="https://cdn.kernel.org/pub/linux/bluetooth">https://cdn.kernel.org/pub/linux/bluetooth</a>
libffi	v3.3-rc0	<a href="https://github.com/libffi/libffi/archive/v3.3-rc0">https://github.com/libffi/libffi/archive/v3.3-rc0</a>
libzlib	1.2.11	<a href="http://www.zlib.net">http://www.zlib.net</a>
xlib_libSM	1.2.3	<a href="http://xorg.freedesktop.org/releases/individual/lib">http://xorg.freedesktop.org/releases/individual/lib</a>
xlib_libICE	1.0.10	<a href="https://xorg.freedesktop.org/archive/individual/lib">https://xorg.freedesktop.org/archive/individual/lib</a>
xlib_xtrans	1.3.5	<a href="http://xorg.freedesktop.org/releases/individual/lib">http://xorg.freedesktop.org/releases/individual/lib</a>
xorgproto	2018.4	<a href="http://xorg.freedesktop.org/releases/individual/proto">http://xorg.freedesktop.org/releases/individual/proto</a>
xlib_libX11	1.6.7	<a href="https://xorg.freedesktop.org/archive/individual/lib">https://xorg.freedesktop.org/archive/individual/lib</a>
libxcb	1.13.1	<a href="http://xcb.freedesktop.org/dist">http://xcb.freedesktop.org/dist</a>
libpthread-stubs	0.4	<a href="http://xcb.freedesktop.org/dist">http://xcb.freedesktop.org/dist</a>
xcb-proto	1.13	<a href="http://xcb.freedesktop.org/dist">http://xcb.freedesktop.org/dist</a>
xlib_libXau	1.0.8	<a href="http://xorg.freedesktop.org/releases/individual/lib">http://xorg.freedesktop.org/releases/individual/lib</a>
xutil_util-macros	1.19.2	<a href="http://xorg.freedesktop.org/releases/individual/util">http://xorg.freedesktop.org/releases/individual/util</a>
xlib_libXdmpc	1.1.3	<a href="http://xorg.freedesktop.org/releases/individual/lib">http://xorg.freedesktop.org/releases/individual/lib</a>
libdaemon	0.14	<a href="http://0pointer.de/lennart/projects/libdaemon">http://0pointer.de/lennart/projects/libdaemon</a>
libglib2	2.56.4	<a href="http://ftp.gnome.org/pub/gnome/sources/glib/2.56">http://ftp.gnome.org/pub/gnome/sources/glib/2.56</a>
elfutils	0.176	<a href="https://sourceware.org/elfutils/ftp/0.176">https://sourceware.org/elfutils/ftp/0.176</a>
bzip2	1.0.8	<a href="https://sourceware.org/pub/bzip2">https://sourceware.org/pub/bzip2</a>
util-linux	2.33	<a href="https://cdn.kernel.org/pub/linux/utils/util-linux/v2.33">https://cdn.kernel.org/pub/linux/utils/util-linux/v2.33</a>
linux-pam	1.3.1	<a href="https://github.com/linux-pam/linux-pam/releases/download/v1.3.1">https://github.com/linux-pam/linux-pam/releases/download/v1.3.1</a>
flex	2.6.4	<a href="https://github.com/westes/flex/files/981163">https://github.com/westes/flex/files/981163</a>
readline	8.0	<a href="http://ftpmirror.gnu.org/readline">http://ftpmirror.gnu.org/readline</a>
bellagio	0.9.3	<a href="http://downloads.sourceforge.net/project/omxil/omxil/Bellagio%200.9.3">http://downloads.sourceforge.net/project/omxil/omxil/Bellagio%200.9.3</a>
bitstream	1.4	<a href="https://get.videolan.org/bitstream/1.4">https://get.videolan.org/bitstream/1.4</a>
bluez5_utils	5.50	<a href="https://cdn.kernel.org/pub/linux/bluetooth">https://cdn.kernel.org/pub/linux/bluetooth</a>
libical	1.0.1	<a href="https://github.com/libical/libical/releases/download/v1.0.1">https://github.com/libical/libical/releases/download/v1.0.1</a>
eudev	3.2.7	<a href="http://dev.gentoo.org/~blueness/eudev">http://dev.gentoo.org/~blueness/eudev</a>
kmod	25	<a href="https://cdn.kernel.org/pub/linux/utils/kernel/kmod">https://cdn.kernel.org/pub/linux/utils/kernel/kmod</a>
bridge-utils	1.6	<a href="https://cdn.kernel.org/pub/linux/utils/net/bridge-utils">https://cdn.kernel.org/pub/linux/utils/net/bridge-utils</a>
busybox	1.29.3	<a href="http://www.busybox.net/downloads">http://www.busybox.net/downloads</a>
dosfstools	4.1	<a href="https://github.com/dosfstools/dosfstools/releases/download/v4.1">https://github.com/dosfstools/dosfstools/releases/download/v4.1</a>
e2fsprogs	1.44.5	<a href="https://cdn.kernel.org/pub/linux/kernel/people/tytso/e2fsprogs/v1.44.5">https://cdn.kernel.org/pub/linux/kernel/people/tytso/e2fsprogs/v1.44.5</a>
iproute2	4.19.0	<a href="https://cdn.kernel.org/pub/linux/utils/net/iproute2">https://cdn.kernel.org/pub/linux/utils/net/iproute2</a>

<b>PACKAGE</b>	<b>VERSION</b>	<b>SOURCE SITE</b>
iptables	1.8.2	<a href="https://netfilter.org/projects/iptables/files">https://netfilter.org/projects/iptables/files</a>
netcat	0.7.1	<a href="http://downloads.sourceforge.net/project/netcat/netcat/0.7.1">http://downloads.sourceforge.net/project/netcat/netcat/0.7.1</a>
ntp	4.2.8p13	<a href="https://www.eecis.udel.edu/~ntp/ntp_spool/ntp4/ntp-4.2">https://www.eecis.udel.edu/~ntp/ntp_spool/ntp4/ntp-4.2</a>
libedit	20180525-3.1	<a href="http://www.thrysoee.dk/editline">http://www.thrysoee.dk/editline</a>
libbsd	0.10.0	<a href="https://libbsd.freedesktop.org/releases">https://libbsd.freedesktop.org/releases</a>
libevent	2.1.8-stable	<a href="https://github.com/libevent/libevent/releases/download/release-2.1.8-stable">https://github.com/libevent/libevent/releases/download/release-2.1.8-stable</a>
libopenssl	1.1.1c	<a href="https://www.openssl.org/source">https://www.openssl.org/source</a>
pciutils	3.5.5	<a href="https://cdn.kernel.org/pub/software/utils/pciutils">https://cdn.kernel.org/pub/software/utils/pciutils</a>
unzip	60	<a href="ftp://ftp.info-zip.org/pub/infozip/src">ftp://ftp.info-zip.org/pub/infozip/src</a>
usbutils	010	<a href="https://cdn.kernel.org/pub/linux/utils/usb/usbutils">https://cdn.kernel.org/pub/linux/utils/usb/usbutils</a>
libusb	1.0.22	<a href="https://github.com/libusb/libusb/releases/download/v1.0.22">https://github.com/libusb/libusb/releases/download/v1.0.22</a>
c-ares	1.15.0	<a href="http://c-ares.haxx.se/download">http://c-ares.haxx.se/download</a>
ca-certificates	20190110	<a href="http://snapshot.debian.org/archive/debian/20190513T145054Z/pool/main/c/ca-certificates">http://snapshot.debian.org/archive/debian/20190513T145054Z/pool/main/c/ca-certificates</a>
collectd	5.7.2	<a href="http://collectd.org/files">http://collectd.org/files</a>
libgcrypt	1.8.4	<a href="https://gnupg.org/ftp/gcrypt/libgcrypt">https://gnupg.org/ftp/gcrypt/libgcrypt</a>
libgpg-error	1.33	<a href="https://www.gnupg.org/ftp/gcrypt/libgpg-error">https://www.gnupg.org/ftp/gcrypt/libgpg-error</a>
lm-sensors	V3-5-0	<a href="https://github.com/lm-sensors/lm-sensors/archive/V3-5-0">https://github.com/lm-sensors/lm-sensors/archive/V3-5-0</a>
crda	4.14	<a href="https://git.kernel.org/pub/scm/linux/kernel/git/mcgrof/crda.git/snapshot">https://git.kernel.org/pub/scm/linux/kernel/git/mcgrof/crda.git/snapshot</a>
libnl	3.4.0	<a href="https://github.com/thom311/libnl/releases/download/libnl3_4_0">https://github.com/thom311/libnl/releases/download/libnl3_4_0</a>
cryptsetup	2.0.6	<a href="https://cdn.kernel.org/pub/linux/utils/cryptsetup/v2.0">https://cdn.kernel.org/pub/linux/utils/cryptsetup/v2.0</a>
json-c	0.13.1	<a href="https://s3.amazonaws.com/json-c_releases/releases">https://s3.amazonaws.com/json-c_releases/releases</a>
lvm2	2.02.183	<a href="ftp://sources.redhat.com/pub/lvm2">ftp://sources.redhat.com/pub/lvm2</a>
libaio	0.3.111	<a href="https://releases.pagure.org/libaio">https://releases.pagure.org/libaio</a>
popt	1.16	<a href="http://rpm5.org/files/popt">http://rpm5.org/files/popt</a>
dhcp	4.3.6	<a href="http://ftp.isc.org/isc/dhcp/4.3.6">http://ftp.isc.org/isc/dhcp/4.3.6</a>
dnsmasq	2.79	<a href="http://thekelleys.org.uk/dnsmasq">http://thekelleys.org.uk/dnsmasq</a>
dropbear	2018.76	<a href="https://matt.ucc.asn.au/dropbear/releases">https://matt.ucc.asn.au/dropbear/releases</a>
dvblast	3.4	<a href="https://get.videolan.org/dvblast/3.4">https://get.videolan.org/dvblast/3.4</a>
libev	4.24	<a href="http://dist.schmorp.de/libev/Attic">http://dist.schmorp.de/libev/Attic</a>
faad2	2.8.8	<a href="http://downloads.sourceforge.net/project/faac/faad2-src/faad2-2.8.0">http://downloads.sourceforge.net/project/faac/faad2-src/faad2-2.8.0</a>
fbv	1.0b	<a href="http://s-tech.elsat.net.pl/fbv">http://s-tech.elsat.net.pl/fbv</a>
giflib	5.1.4	<a href="http://downloads.sourceforge.net/project/giflib">http://downloads.sourceforge.net/project/giflib</a>
jpeg-turbo	2.0.1	<a href="https://downloads.sourceforge.net/project/libjpeg-turbo/2.0.1">https://downloads.sourceforge.net/project/libjpeg-turbo/2.0.1</a>

<b>PACKAGE</b>	<b>VERSION</b>	<b>SOURCE SITE</b>
libpng	1.6.37	<a href="http://downloads.sourceforge.net/project/libpng/libpng16/1.6.37">http://downloads.sourceforge.net/project/libpng/libpng16/1.6.37</a>
ffmpeg	3.4.6	<a href="http://ffmpeg.org/releases">http://ffmpeg.org/releases</a>
fontconfig	2.13.1	<a href="http://fontconfig.org/release">http://fontconfig.org/release</a>
freetype	2.9.1	<a href="http://download.savannah.gnu.org/releases/freetype">http://download.savannah.gnu.org/releases/freetype</a>
libva	2.4.0	<a href="https://github.com/intel/libva/releases/download/2.4.0">https://github.com/intel/libva/releases/download/2.4.0</a>
libdrm	2.4.97	<a href="https://dri.freedesktop.org/libdrm">https://dri.freedesktop.org/libdrm</a>
mesa3d	18.3.6	<a href="https://mesa.freedesktop.org/archive">https://mesa.freedesktop.org/archive</a>
libva-dummy	2.4.0	<a href="https://github.com/intel/libva/releases/download/2.4.0">https://github.com/intel/libva/releases/download/2.4.0</a>
xlib_libXext	1.3.3	<a href="http://xorg.freedesktop.org/releases/individual/lib">http://xorg.freedesktop.org/releases/individual/lib</a>
xlib_libXfixes	5.0.3	<a href="http://xorg.freedesktop.org/releases/individual/lib">http://xorg.freedesktop.org/releases/individual/lib</a>
libvdpau	1.1.1	<a href="http://people.freedesktop.org/~aplattner/vdpau">http://people.freedesktop.org/~aplattner/vdpau</a>
llvm	7.0.1	<a href="http://llvm.org/releases/7.0.1">http://llvm.org/releases/7.0.1</a>
xlib_libXdamage	1.1.4	<a href="http://xorg.freedesktop.org/releases/individual/lib">http://xorg.freedesktop.org/releases/individual/lib</a>
xlib_libXrandr	1.5.1	<a href="http://xorg.freedesktop.org/releases/individual/lib">http://xorg.freedesktop.org/releases/individual/lib</a>
xlib_libXrender	0.9.10	<a href="http://xorg.freedesktop.org/releases/individual/lib">http://xorg.freedesktop.org/releases/individual/lib</a>
xlib_libXxf86vm	1.1.4	<a href="http://xorg.freedesktop.org/releases/individual/lib">http://xorg.freedesktop.org/releases/individual/lib</a>
xlib_libxshmfence	1.3	<a href="http://xorg.freedesktop.org/releases/individual/lib">http://xorg.freedesktop.org/releases/individual/lib</a>
libvorbis	1.3.6	<a href="http://downloads.xiph.org/releases/vorbis">http://downloads.xiph.org/releases/vorbis</a>
libogg	1.3.3	<a href="http://downloads.xiph.org/releases/ogg">http://downloads.xiph.org/releases/ogg</a>
libvpx	v1.7.0	<a href="https://github.com/webmproject/libvpx/archive/v1.7.0">https://github.com/webmproject/libvpx/archive/v1.7.0</a>
opus	1.3.1	<a href="https://downloads.xiph.org/releases/opus">https://downloads.xiph.org/releases/opus</a>
speex	1.2.0	<a href="https://downloads.xiph.org/releases/speex">https://downloads.xiph.org/releases/speex</a>
file	5.36	<a href="ftp://ftp.astron.com/pub/file">ftp://ftp.astron.com/pub/file</a>
flashrom	1.0	<a href="https://download.flashrom.org/releases">https://download.flashrom.org/releases</a>
gdb	8.1.1	<a href="http://ftpmirror.gnu.org/gdb">http://ftpmirror.gnu.org/gdb</a>
gnu-efi	3.0.9	<a href="http://downloads.sourceforge.net/project/gnu-efi">http://downloads.sourceforge.net/project/gnu-efi</a>
gnupg2	2.2.17	<a href="https://gnupg.org/ftp/gcrypt/gnupg">https://gnupg.org/ftp/gcrypt/gnupg</a>
libassuan	2.5.2	<a href="ftp://ftp.gnupg.org/gcrypt/libassuan">ftp://ftp.gnupg.org/gcrypt/libassuan</a>
libksba	1.3.5	<a href="ftp://ftp.gnupg.org/gcrypt/libksba">ftp://ftp.gnupg.org/gcrypt/libksba</a>
libnpth	1.6	<a href="https://www.gnupg.org/ftp/gcrypt/npth">https://www.gnupg.org/ftp/gcrypt/npth</a>
sqlite	3280000	<a href="https://www.sqlite.org/2019">https://www.sqlite.org/2019</a>
gssdp	1.0.2	<a href="http://ftp.gnome.org/pub/gnome/sources/gssdp/1.0">http://ftp.gnome.org/pub/gnome/sources/gssdp/1.0</a>

<b>PACKAGE</b>	<b>VERSION</b>	<b>SOURCE SITE</b>
libsoup	2.62.3	<a href="http://ftp.gnome.org/pub/gnome/sources/libsoup/2.62">http://ftp.gnome.org/pub/gnome/sources/libsoup/2.62</a>
libxml2	2.9.9	<a href="http://xmlsoft.org/sources">http://xmlsoft.org/sources</a>
gst1-libav	1.14.4	<a href="https://gstreamer.freedesktop.org/src/gst-libav">https://gstreamer.freedesktop.org/src/gst-libav</a>
gst1-plugins-base	1.14.4	<a href="https://gstreamer.freedesktop.org/src/gst-plugins-base">https://gstreamer.freedesktop.org/src/gst-plugins-base</a>
gstreamer1	1.14.4	<a href="https://gstreamer.freedesktop.org/src/gstreamer">https://gstreamer.freedesktop.org/src/gstreamer</a>
xlib_libXv	1.0.11	<a href="http://xorg.freedesktop.org/releases/individual/lib">http://xorg.freedesktop.org/releases/individual/lib</a>
gst1-plugins-bad	1.14.4	<a href="https://gstreamer.freedesktop.org/src/gst-plugins-bad">https://gstreamer.freedesktop.org/src/gst-plugins-bad</a>
gst1-plugins-good	1.14.4	<a href="https://gstreamer.freedesktop.org/src/gst-plugins-good">https://gstreamer.freedesktop.org/src/gst-plugins-good</a>
libv4l	1.16.3	<a href="https://linuxtv.org/downloads/v4l-utils">https://linuxtv.org/downloads/v4l-utils</a>
qt5base	5.12.4	<a href="https://download.qt.io/archive/qt/5.12/5.12.4/submodules">https://download.qt.io/archive/qt/5.12/5.12.4/submodules</a>
icu	60.2	<a href="http://download.icu-project.org/files/icu4c/60.2">http://download.icu-project.org/files/icu4c/60.2</a>
libxkbcommon	0.8.2	<a href="http://xkbcommon.org/download">http://xkbcommon.org/download</a>
pcre2	10.32	<a href="https://ftp.pcre.org/pub/pcre">https://ftp.pcre.org/pub/pcre</a>
xcb-util-image	0.4.0	<a href="http://xcb.freedesktop.org/dist">http://xcb.freedesktop.org/dist</a>
xcb-util	0.4.0	<a href="http://xcb.freedesktop.org/dist">http://xcb.freedesktop.org/dist</a>
xcb-util-keysyms	0.4.0	<a href="http://xcb.freedesktop.org/dist">http://xcb.freedesktop.org/dist</a>
xcb-util-wm	0.4.1	<a href="http://xcb.freedesktop.org/dist">http://xcb.freedesktop.org/dist</a>
gst1-vaapi	1.14.4	<a href="https://gstreamer.freedesktop.org/src/gstreamer-vaapi">https://gstreamer.freedesktop.org/src/gstreamer-vaapi</a>
htop	2.2.0	<a href="http://hisham.hm/htop/releases/2.2.0">http://hisham.hm/htop/releases/2.2.0</a>
hwdata	v0.308	<a href="https://github.com/vcrhonek/hwdata/archive/v0.308">https://github.com/vcrhonek/hwdata/archive/v0.308</a>
iperf	2.0.13	<a href="http://downloads.sourceforge.net/project/iperf2">http://downloads.sourceforge.net/project/iperf2</a>
iw	4.14	<a href="https://cdn.kernel.org/pub/software/network/iw">https://cdn.kernel.org/pub/software/network/iw</a>
jansson	2.12	<a href="http://www.digip.org/jansson/releases">http://www.digip.org/jansson/releases</a>
jose	10	<a href="https://github.com/latchset/jose/releases/download/v10">https://github.com/latchset/jose/releases/download/v10</a>
jsoncpp	1.8.4	<a href="https://github.com/open-source-parsers/jsoncpp/archive/1.8.4">https://github.com/open-source-parsers/jsoncpp/archive/1.8.4</a>
libarchive	3.3.3	<a href="http://www.libarchive.org/downloads">http://www.libarchive.org/downloads</a>
libconfig	v1.7.2	<a href="https://github.com/hyperrealm/libconfig/archive/v1.7.2">https://github.com/hyperrealm/libconfig/archive/v1.7.2</a>
libcurl	7.65.3	<a href="https://curl.haxx.se/download">https://curl.haxx.se/download</a>
libdri2	4f1eef3183df2-b270c3d5cbe-f07343ee5127-a6a4	<a href="https://github.com/robclark/libdri2/archive/4f1eef3183df2b270c3d5cbef07343ee5127a6a4">https://github.com/robclark/libdri2/archive/4f1eef3183df2b270c3d5cbef07343ee5127a6a4</a>
libepoxy	1.5.2	<a href="http://ftp.gnome.org/pub/gnome/sources/libepoxy/1.5">http://ftp.gnome.org/pub/gnome/sources/libepoxy/1.5</a>

<b>PACKAGE</b>	<b>VERSION</b>	<b>SOURCE SITE</b>
libestr	0.1.10	<a href="http://libestr.adiscon.com/files/download">http://libestr.adiscon.com/files/download</a>
libevdev	1.6.0	<a href="http://www.freedesktop.org/software/libevdev">http://www.freedesktop.org/software/libevdev</a>
libfastjson	v0.99.8	<a href="https://github.com/rsyslog/libfastjson/archive/v0.99.8">https://github.com/rsyslog/libfastjson/archive/v0.99.8</a>
libhttpparser	v2.9.0	<a href="https://github.com/nodejs/http-parser/archive/v2.9.0">https://github.com/nodejs/http-parser/archive/v2.9.0</a>
liblogging	1.0.6	<a href="http://download.rsyslog.com/liblogging">http://download.rsyslog.com/liblogging</a>
libnspr	4.20	<a href="https://ftp.mozilla.org/pub/mozilla.org/nspr/releases/v4.20/src">https://ftp.mozilla.org/pub/mozilla.org/nspr/releases/v4.20/src</a>
libnss	3.42.1	<a href="https://ftp.mozilla.org/pub/mozilla.org/security/nss/releases/NSS_3_42_1_RTM/src">https://ftp.mozilla.org/pub/mozilla.org/security/nss/releases/NSS_3_42_1_RTM/src</a>
libopusenc	0.2.1	<a href="https://downloads.xiph.org/releases/opus">https://downloads.xiph.org/releases/opus</a>
libpcap	1.9.0	<a href="http://www.tcpdump.org/release">http://www.tcpdump.org/release</a>
libpciaccess	0.14	<a href="http://xorg.freedesktop.org/releases/individual/lib">http://xorg.freedesktop.org/releases/individual/lib</a>
libqrencode	4.0.0	<a href="http://fukuchi.org/works/qrencode">http://fukuchi.org/works/qrencode</a>
libsha1	0.3	<a href="https://github.com/dottedmag/libsha1/archive/0.3">https://github.com/dottedmag/libsha1/archive/0.3</a>
libtool	2.4.6	<a href="http://ftpmirror.gnu.org/libtool">http://ftpmirror.gnu.org/libtool</a>
libuv	v1.25.0	<a href="https://github.com/libuv/libuv/archive/v1.25.0">https://github.com/libuv/libuv/archive/v1.25.0</a>
libyaml	0.2.1	<a href="http://pyyaml.org/download/libyaml">http://pyyaml.org/download/libyaml</a>
libzip	1.5.1	<a href="http://www.nih.at/libzip">http://www.nih.at/libzip</a>
lighttpd	1.4.53	<a href="http://download.lighttpd.net/lighttpd/releases-1.4.x">http://download.lighttpd.net/lighttpd/releases-1.4.x</a>
linux-firmware	1baa34868b2-c0a004dc595-b20678145e3ff83e7	<a href="http://git.kernel.org/pub/scm/linux/kernel/git/firmware/linux-firmware.git">http://git.kernel.org/pub/scm/linux/kernel/git/firmware/linux-firmware.git</a>
logrotate	3.13.0	<a href="https://github.com/logrotate/logrotate/archive/3.13.0">https://github.com/logrotate/logrotate/archive/3.13.0</a>
memtester	4.3.0	<a href="http://pyropus.ca/software/memtester/old-versions">http://pyropus.ca/software/memtester/old-versions</a>
monit	5.25.3	<a href="http://mmonit.com/monit/dist">http://mmonit.com/monit/dist</a>
mtdev	1.1.4	<a href="http://bitmath.org/code/mtdev">http://bitmath.org/code/mtdev</a>
netsnmp	5.8	<a href="https://downloads.sourceforge.net/project/net-snmp/net-snmp/5.8">https://downloads.sourceforge.net/project/net-snmp/net-snmp/5.8</a>
nodejs	8.15.1	<a href="http://nodejs.org/dist/v8.15.1">http://nodejs.org/dist/v8.15.1</a>
opkg	0.3.6	<a href="http://downloads.yoctoproject.org/releases/opkg">http://downloads.yoctoproject.org/releases/opkg</a>
opus-tools	0.2	<a href="https://downloads.xiph.org/releases/opus">https://downloads.xiph.org/releases/opus</a>
opusfile	0.11	<a href="https://downloads.xiph.org/releases/opus">https://downloads.xiph.org/releases/opus</a>
php	7.3.9	<a href="http://www.php.net/distributions">http://www.php.net/distributions</a>
pixman	0.34.0	<a href="http://xorg.freedesktop.org/releases/individual/lib">http://xorg.freedesktop.org/releases/individual/lib</a>
portaudio	v190600_20161030	<a href="http://www.portaudio.com/archives">http://www.portaudio.com/archives</a>
powertop	2.9	<a href="https://01.org/sites/default/files/downloads/powertop">https://01.org/sites/default/files/downloads/powertop</a>

<b>PACKAGE</b>	<b>VERSION</b>	<b>SOURCE SITE</b>
protobuf	v2.6.1	<a href="https://github.com/google/protobuf/archive/v2.6.1">https://github.com/google/protobuf/archive/v2.6.1</a>
python-pyyaml	4.2b4	<a href="https://files.pythonhosted.org/packages/a8/c6/a8d1555e795dbd0375c3c93b576ca13bbf139db51ea604a-fa19a2c35fc03">https://files.pythonhosted.org/packages/a8/c6/a8d1555e795dbd0375c3c93b576ca13bbf139db51ea604a-fa19a2c35fc03</a>
python-serial	3.4	<a href="https://files.pythonhosted.org/packages/cc/74/11b04703ec416717b247d789103277269d567db575d2fd88f25d9767f-e3d">https://files.pythonhosted.org/packages/cc/74/11b04703ec416717b247d789103277269d567db575d2fd88f25d9767f-e3d</a>
qt5declarative	5.12.4	<a href="https://download.qt.io/archive/qt/5.12/5.12.4/submodules">https://download.qt.io/archive/qt/5.12/5.12.4/submodules</a>
qt5xmlpatterns	5.12.4	<a href="https://download.qt.io/archive/qt/5.12/5.12.4/submodules">https://download.qt.io/archive/qt/5.12/5.12.4/submodules</a>
qt5graphical-effects	5.12.4	<a href="https://download.qt.io/archive/qt/5.12/5.12.4/submodules">https://download.qt.io/archive/qt/5.12/5.12.4/submodules</a>
qt5imageformats	5.12.4	<a href="https://download.qt.io/archive/qt/5.12/5.12.4/submodules">https://download.qt.io/archive/qt/5.12/5.12.4/submodules</a>
qt5multimedia	5.12.4	<a href="https://download.qt.io/archive/qt/5.12/5.12.4/submodules">https://download.qt.io/archive/qt/5.12/5.12.4/submodules</a>
qt5quickcontrols	5.12.4	<a href="https://download.qt.io/archive/qt/5.12/5.12.4/submodules">https://download.qt.io/archive/qt/5.12/5.12.4/submodules</a>
qt5quickcontrols2	5.12.4	<a href="https://download.qt.io/archive/qt/5.12/5.12.4/submodules">https://download.qt.io/archive/qt/5.12/5.12.4/submodules</a>
qt5serialport	5.12.4	<a href="https://download.qt.io/archive/qt/5.12/5.12.4/submodules">https://download.qt.io/archive/qt/5.12/5.12.4/submodules</a>
qt5svg	5.12.4	<a href="https://download.qt.io/archive/qt/5.12/5.12.4/submodules">https://download.qt.io/archive/qt/5.12/5.12.4/submodules</a>
qt5tools	5.12.4	<a href="https://download.qt.io/archive/qt/5.12/5.12.4/submodules">https://download.qt.io/archive/qt/5.12/5.12.4/submodules</a>
qt5webchannel	5.12.4	<a href="https://download.qt.io/archive/qt/5.12/5.12.4/submodules">https://download.qt.io/archive/qt/5.12/5.12.4/submodules</a>
qt5websockets	5.12.4	<a href="https://download.qt.io/archive/qt/5.12/5.12.4/submodules">https://download.qt.io/archive/qt/5.12/5.12.4/submodules</a>
qt5webengine	5.12.4	<a href="https://download.qt.io/archive/qt/5.12/5.12.4/submodules">https://download.qt.io/archive/qt/5.12/5.12.4/submodules</a>
webp	1.0.1	<a href="http://downloads.webmproject.org/releases/webp">http://downloads.webmproject.org/releases/webp</a>
xlib_ libXScrnSaver	1.2.3	<a href="http://xorg.freedesktop.org/releases/individual/lib">http://xorg.freedesktop.org/releases/individual/lib</a>
xlib_ libXcomposite	0.4.4	<a href="http://xorg.freedesktop.org/releases/individual/lib">http://xorg.freedesktop.org/releases/individual/lib</a>
xlib_ libXcursor	1.1.15	<a href="http://xorg.freedesktop.org/releases/individual/lib">http://xorg.freedesktop.org/releases/individual/lib</a>
xlib_ libXi	1.7.9	<a href="http://xorg.freedesktop.org/releases/individual/lib">http://xorg.freedesktop.org/releases/individual/lib</a>
xlib_ libXtst	1.2.3	<a href="http://xorg.freedesktop.org/releases/individual/lib">http://xorg.freedesktop.org/releases/individual/lib</a>
qt5x11extras	5.12.4	<a href="https://download.qt.io/archive/qt/5.12/5.12.4/submodules">https://download.qt.io/archive/qt/5.12/5.12.4/submodules</a>
ramspeed	2.6.0	<a href="http://www.alasir.com/software/ramspeed">http://www.alasir.com/software/ramspeed</a>
rsync	3.1.3	<a href="http://rsync.samba.org/ftp/rsync/src">http://rsync.samba.org/ftp/rsync/src</a>
rsyslog	8.22.0	<a href="http://rsyslog.com/files/download/rsyslog">http://rsyslog.com/files/download/rsyslog</a>
strace	4.26	<a href="https://strace.io/files/4.26">https://strace.io/files/4.26</a>
tcpdump	4.9.2	<a href="http://www.tcpdump.org/release">http://www.tcpdump.org/release</a>



<b>PACKAGE</b>	<b>VERSION</b>	<b>SOURCE SITE</b>
tpm-tools	1.3.9.1	<a href="http://downloads.sourceforge.net/project/trousers/tpm-tools/1.3.9.1">http://downloads.sourceforge.net/project/trousers/tpm-tools/1.3.9.1</a>
trousers	0.3.14	<a href="http://downloads.sourceforge.net/project/trousers/trousers/0.3.14">http://downloads.sourceforge.net/project/trousers/trousers/0.3.14</a>
tzdata	2018e	<a href="http://www.iana.org/time-zones/repository/releases">http://www.iana.org/time-zones/repository/releases</a>
wireless-regdb	2019.06.03	<a href="https://cdn.kernel.org/pub/software/network/wireless-regdb">https://cdn.kernel.org/pub/software/network/wireless-regdb</a>
wireless_tools	30.pre9	<a href="https://hewlettpackard.github.io/wireless-tools">https://hewlettpackard.github.io/wireless-tools</a>
xapp_ beforelight	1.0.5	<a href="http://xorg.freedesktop.org/releases/individual/app">http://xorg.freedesktop.org/releases/individual/app</a>
xlib_libXaw	1.0.13	<a href="http://xorg.freedesktop.org/releases/individual/lib">http://xorg.freedesktop.org/releases/individual/lib</a>
xlib_libXmu	1.1.2	<a href="http://xorg.freedesktop.org/releases/individual/lib">http://xorg.freedesktop.org/releases/individual/lib</a>
xlib_libXt	1.1.5	<a href="http://xorg.freedesktop.org/releases/individual/lib">http://xorg.freedesktop.org/releases/individual/lib</a>
xlib_libXpm	3.5.12	<a href="http://xorg.freedesktop.org/releases/individual/lib">http://xorg.freedesktop.org/releases/individual/lib</a>
xapp_xauth	1.0.10	<a href="http://xorg.freedesktop.org/releases/individual/app">http://xorg.freedesktop.org/releases/individual/app</a>
xapp_xclock	1.0.7	<a href="http://xorg.freedesktop.org/releases/individual/app">http://xorg.freedesktop.org/releases/individual/app</a>
xlib_libXft	2.3.2	<a href="http://xorg.freedesktop.org/releases/individual/lib">http://xorg.freedesktop.org/releases/individual/lib</a>
xlib_libxkbfile	1.0.9	<a href="http://xorg.freedesktop.org/releases/individual/lib">http://xorg.freedesktop.org/releases/individual/lib</a>
xapp_xinit	1.4.0	<a href="http://xorg.freedesktop.org/releases/individual/app">http://xorg.freedesktop.org/releases/individual/app</a>
xapp_xinput- calibrator	0.7.5	<a href="http://github.com/downloads/tias/xinput_calibrator">http://github.com/downloads/tias/xinput_calibrator</a>
xapp_xinput	1.6.2	<a href="http://xorg.freedesktop.org/releases/individual/app">http://xorg.freedesktop.org/releases/individual/app</a>
xlib_ libXinerama	1.1.4	<a href="http://xorg.freedesktop.org/releases/individual/lib">http://xorg.freedesktop.org/releases/individual/lib</a>
xapp_ xkbcomp	1.4.2	<a href="http://xorg.freedesktop.org/releases/individual/app">http://xorg.freedesktop.org/releases/individual/app</a>
xapp_xrandr	1.5.0	<a href="http://xorg.freedesktop.org/releases/individual/app">http://xorg.freedesktop.org/releases/individual/app</a>
xdata_ xbitmaps	1.1.2	<a href="http://xorg.freedesktop.org/releases/individual/data">http://xorg.freedesktop.org/releases/individual/data</a>
xdriver_xf86- input-evdev	2.10.5	<a href="http://xorg.freedesktop.org/releases/individual/driver">http://xorg.freedesktop.org/releases/individual/driver</a>
xserver_xorg- server	1.20.5	<a href="https://xorg.freedesktop.org/archive/individual/xserver">https://xorg.freedesktop.org/archive/individual/xserver</a>
xfont_font-util	1.3.2	<a href="http://xorg.freedesktop.org/releases/individual/font">http://xorg.freedesktop.org/releases/individual/font</a>
xkeyboard- config	2.23.1	<a href="http://www.x.org/releases/individual/data/xkeyboard-config">http://www.x.org/releases/individual/data/xkeyboard-config</a>
xlib_libXfont2	2.0.3	<a href="http://xorg.freedesktop.org/releases/individual/lib">http://xorg.freedesktop.org/releases/individual/lib</a>
xfont_ encodings	1.0.4	<a href="http://xorg.freedesktop.org/releases/individual/font">http://xorg.freedesktop.org/releases/individual/font</a>
xlib_libfontenc	1.1.3	<a href="http://xorg.freedesktop.org/releases/individual/lib">http://xorg.freedesktop.org/releases/individual/lib</a>
xlib_libXres	1.2.0	<a href="http://xorg.freedesktop.org/releases/individual/lib">http://xorg.freedesktop.org/releases/individual/lib</a>

<b>PACKAGE</b>	<b>VERSION</b>	<b>SOURCE SITE</b>
xdriver_xf86-video-amdgpu	18.1.0	<a href="http://xorg.freedesktop.org/releases/individual/driver">http://xorg.freedesktop.org/releases/individual/driver</a>
xfont_font-alias	1.0.3	<a href="http://xorg.freedesktop.org/releases/individual/font">http://xorg.freedesktop.org/releases/individual/font</a>
xfont_font-cursor-misc	1.0.3	<a href="http://xorg.freedesktop.org/releases/individual/font">http://xorg.freedesktop.org/releases/individual/font</a>
xfont_font-misc-misc	1.1.2	<a href="http://xorg.freedesktop.org/releases/individual/font">http://xorg.freedesktop.org/releases/individual/font</a>
xterm	327	<a href="http://invisible-mirror.net/archives/xterm">http://invisible-mirror.net/archives/xterm</a>
zip	30	<a href="ftp://ftp.info-zip.org/pub/infozip/src">ftp://ftp.info-zip.org/pub/infozip/src</a>
splashutils	1.5.4.4	<a href="http://dev.gentoo.org/~spock/projects/gensplash/archive">http://dev.gentoo.org/~spock/projects/gensplash/archive</a>
libresample	0.1.3	<a href="ftp://ftp.ubuntu.com/ubuntu/pool/universe/libr/libresample">ftp://ftp.ubuntu.com/ubuntu/pool/universe/libr/libresample</a>
alsa-plugins	1.1.1	<a href="ftp://ftp.alsa-project.org/pub/plugins">ftp://ftp.alsa-project.org/pub/plugins</a>
arphic-uming-fonts	20080216	<a href="http://archive.ubuntu.com/ubuntu/pool/main/t/ttf-arphic-uming">http://archive.ubuntu.com/ubuntu/pool/main/t/ttf-arphic-uming</a>
dejavu-fonts	2.34	<a href="http://downloads.sourceforge.net/project/dejavu/dejavu/2.34">http://downloads.sourceforge.net/project/dejavu/dejavu/2.34</a>
efitools	v1.7.0	<a href="git://git.kernel.org/pub/scm/linux/kernel/git/jejb/efitools.git">git://git.kernel.org/pub/scm/linux/kernel/git/jejb/efitools.git</a>
sazanami-fonts	20040629	<a href="http://sourceforge.jp/projects/efont/downloads/10087">http://sourceforge.jp/projects/efont/downloads/10087</a>
unfonts	1.0	<a href="http://kldp.net/frs/download.php/1425">http://kldp.net/frs/download.php/1425</a>
fbset	2.1	<a href="http://users.telenet.be/geertu/Linux/fbdev">http://users.telenet.be/geertu/Linux/fbdev</a>
gzip	1.9	<a href="http://ftpmirror.gnu.org/gzip">http://ftpmirror.gnu.org/gzip</a>
i2c-tools	4.1	<a href="https://www.kernel.org/pub/software/utils/i2c-tools">https://www.kernel.org/pub/software/utils/i2c-tools</a>
tar	1.29	<a href="http://ftpmirror.gnu.org/tar">http://ftpmirror.gnu.org/tar</a>
devmem2	1	<a href="http://bootlin.com/pub/mirror">http://bootlin.com/pub/mirror</a>
efibootmgr	15	<a href="https://github.com/rhboot/efibootmgr/archive/15">https://github.com/rhboot/efibootmgr/archive/15</a>
efivar	35	<a href="https://github.com/rhboot/efivar/archive/35">https://github.com/rhboot/efivar/archive/35</a>
parted	3.2	<a href="http://ftpmirror.gnu.org/parted">http://ftpmirror.gnu.org/parted</a>
linux	v4.9.181	<a href="https://mirrors.edge.kernel.org/pub/linux/kernel/v4.x/">https://mirrors.edge.kernel.org/pub/linux/kernel/v4.x/</a>
ibmswtpm	4720	<a href="https://sourceforge.net/projects/ibmswtpm/files/">https://sourceforge.net/projects/ibmswtpm/files/</a>
grub	2.02-beta2	<a href="https://github.com/coreos/grub/releases">https://github.com/coreos/grub/releases</a>
hostapd	40e2dcfd4-e27191d4fb9e-dc6c10337868-b90acf	<a href="https://source.codeaurora.org/quic/la/platform/external/wpa_supplicant_8">https://source.codeaurora.org/quic/la/platform/external/wpa_supplicant_8</a>
wpa_supplicant	40e2dcfd4-e27191d4fb9e-dc6c10337868-b90acf	<a href="https://source.codeaurora.org/quic/la/platform/external/wpa_supplicant_8">https://source.codeaurora.org/quic/la/platform/external/wpa_supplicant_8</a>
qca6174a	CNSS.LEA.NRT_1.0	<a href="https://source.codeaurora.org/external/wlan/qcacl2-2.0/">https://source.codeaurora.org/external/wlan/qcacl2-2.0/</a>

<b>PACKAGE</b>	<b>VERSION</b>	<b>SOURCE SITE</b>
qca93777	CNSS.LEA. NRT_1.0	<a href="https://source.codeaurora.org/external/wlan/qcaclid-2.0/">https://source.codeaurora.org/external/wlan/qcaclid-2.0/</a>
rscodex	1.3	<a href="https://sourceforge.net/projects/rscodex/files/rscodex/">https://sourceforge.net/projects/rscodex/files/rscodex/</a>
nlohmann:: json	3.7.3	<a href="https://github.com/nlohmann/json">https://github.com/nlohmann/json</a>
azure-iot-c- sdk	2019-10-07	<a href="https://github.com/Azure/azure-iot-sdk-c">https://github.com/Azure/azure-iot-sdk-c</a>
angular	7.2.0	<a href="https://github.com/angular/angular.git">https://github.com/angular/angular.git</a>
bcrypt	3.0.6	<a href="https://github.com/kelektiv/node.bcrypt.js">https://github.com/kelektiv/node.bcrypt.js</a>
bcryptjs	2.4.3	<a href="https://github.com/dcodeIO/bcrypt.js">https://github.com/dcodeIO/bcrypt.js</a>
body-parser	1.18.3	<a href="https://github.com/expressjs/body-parser">https://github.com/expressjs/body-parser</a>
bootstrap	4.3.1	<a href="https://getbootstrap.com/">https://getbootstrap.com/</a>
bunyan	1.8.12	<a href="https://github.com/trentm/node-bunyan">https://github.com/trentm/node-bunyan</a>
bunyan- prettystream	0.1.3	<a href="https://github.com/trentm/node-bunyan">https://github.com/trentm/node-bunyan</a>
bunyan-syslog	0.3.2	<a href="https://github.com/trentm/node-bunyan">https://github.com/trentm/node-bunyan</a>
chromedriver	77.0.0	<a href="https://github.com/giggio/node-chromedriver">https://github.com/giggio/node-chromedriver</a>
Core-js	2.5.4	<a href="https://github.com/zloirock/core-js">https://github.com/zloirock/core-js</a>
cors	2.8.5	<a href="https://github.com/expressjs/cors">https://github.com/expressjs/cors</a>
dbus-native	0.4.0	<a href="https://github.com/sidorares/dbus-native">https://github.com/sidorares/dbus-native</a>
express	4.16.4	<a href="https://github.com/expressjs/express">https://github.com/expressjs/express</a>
generate- password	1.4.2	<a href="https://github.com/brendanashworth/generate-password">https://github.com/brendanashworth/generate-password</a>
inversify	5.0.1	<a href="http://inversify.io/">http://inversify.io/</a>
jquery	3.4.1	<a href="https://jquery.com/">https://jquery.com/</a>
js-yaml	3.12.0	<a href="https://github.com/nodeca/js-yaml">https://github.com/nodeca/js-yaml</a>
moment	2.24.0	<a href="http://momentjs.com/">http://momentjs.com/</a>
morgan	1.9.1	<a href="https://github.com/expressjs/morgan">https://github.com/expressjs/morgan</a>
multer	1.4.1	<a href="https://github.com/expressjs/multer">https://github.com/expressjs/multer</a>
ngx-cookie- service	2.2.0	<a href="https://github.com/7leads/ngx-cookie-service">https://github.com/7leads/ngx-cookie-service</a>
npm	6.10.2	<a href="https://docs.npmjs.com">https://docs.npmjs.com</a>
passport	0.4.0	<a href="http://github.com/jaredhanson/passport">http://github.com/jaredhanson/passport</a>
passport-http	0.3.0	<a href="http://github.com/jaredhanson/passport-http">http://github.com/jaredhanson/passport-http</a>
popper.js	1.15.0	<a href="https://popper.js.org">https://popper.js.org</a>
reflect- metadata	0.1.13	<a href="http://rbuckton.github.io/reflect-metadata">http://rbuckton.github.io/reflect-metadata</a>

<b>PACKAGE</b>	<b>VERSION</b>	<b>SOURCE SITE</b>
rxjs	6.3.3	<a href="https://github.com/ReactiveX/RxJS">https://github.com/ReactiveX/RxJS</a>
swagger-parser	6.0.5	<a href="https://github.com/APIDevTools/swagger-parser">https://github.com/APIDevTools/swagger-parser</a>
swagger-ui-express	4.0.1	<a href="https://github.com/scottie1984/swagger-ui-express">https://github.com/scottie1984/swagger-ui-express</a>
tslib	1.9.0	<a href="http://typescriptlang.org">http://typescriptlang.org</a>
ws	7.1.1	<a href="https://github.com/websockets/ws">https://github.com/websockets/ws</a>
zone.js	0.8.26	<a href="https://github.com/angular/zone.js">https://github.com/angular/zone.js</a>
NXP-SDK	2.5.0	<a href="https://www.nxp.com/support/developer-resources/software-development-tools/mcuxpresso-software-and-tools/mcuxpresso-software-development-kit-sdk:MCUXpresso-SDK?tab=Design_Tools_Tab">https://www.nxp.com/support/developer-resources/software-development-tools/mcuxpresso-software-and-tools/mcuxpresso-software-development-kit-sdk:MCUXpresso-SDK?tab=Design_Tools_Tab</a>
unlz4	-	<a href="https://github.com/lz4/lz4/blob/dev/lib/lz4.h">https://github.com/lz4/lz4/blob/dev/lib/lz4.h</a>
ring-buff	-	<a href="https://code.google.com/archive/p/ring-buff/">https://code.google.com/archive/p/ring-buff/</a>
wpa_supplicant	2.6	<a href="http://w1.fi/wpa_supplicant/">http://w1.fi/wpa_supplicant/</a>

### **EN55032-CISPR32 Class B ITE (Information Technology Equipment)**

This is a class B product. In a domestic environment this product may cause radio interference in which case the user may be required to take adequate measures.

If this equipment does cause interference to radio or television reception, the user may try to correct the interference by one or more of the following measures :

- Re-orientation of the receiving antenna for the radio or television.
- Relocate the equipment with respect to the receiver.
- Plug the equipment into a different outlet so that the equipment and receiver are on different branch circuits.
- Fasten cables connectors to the equipment by mounting screws.

### **Federal Communication Commission Interference Statement**

You are cautioned that changes or modifications not expressly approved by the part responsible for compliance could void the user's authority to operate the equipment.

This equipment has been tested and found to comply with the limits for a Class B digital device, pursuant to Part 15 of the FCC rules. These limits are designed to provide reasonable protection against harmful interference in a residential installation. This equipment generates, uses and can radiate radio frequency energy and, if not installed and used in accordance with the instructions, may cause harmful interference to radio communications. However, there is no guarantee that interference will not occur in a particular installation.

If this equipment does cause harmful interference to radio or television reception, which can be determined by turning the equipment off and on, the user is encouraged to try to correct the interference by one or more of the following measures:

- Reorient or relocate the receiving antenna.
- Increase the separation between the equipment and receiver.
- Connect the equipment into an outlet on a circuit different from that to which the receiver is connected.
- Consult the dealer or an experienced radio/TV technician for help.

You may also find helpful the following booklet, prepared by the FCC: "How to Identify and Resolve Radio-TV Interference Problems." This booklet is available from the U.S. Government Printing Office, Washington D.C. 20402.

Changes and Modifications not expressly approved by the manufacturer or registrant of this equipment can void your authority to operate this equipment under Federal Communications Commissions rules.

In order to maintain compliance with FCC regulations shielded cables must be used with this equipment. Operation with non-approved equipment or unshielded cables is likely to result in interference to radio & television reception.

**FCC RF Radiation Exposure Statement:** This device is capable of operating in 802.11a mode. For 802.11a devices operating in the frequency range of 5.15 - 5.25 GHz, they are restricted for indoor operations to reduce any potential harmful interference for Mobile Satellite Services (MSS) in the US. WIFI Access Points that are capable of allowing your device to operate in 802.11a mode (5.15 - 5.25 GHz band) are optimized for indoor use only. If your WIFI network is capable of operating in this mode, please restrict your WIFI use indoors to not violate federal regulations to protect Mobile Satellite Services.

1. This Transmitter must not be co-located or operating in conjunction with any other antenna or transmitter.
2. This equipment complies with RF radiation exposure limits set forth for an uncontrolled environment.

This equipment should be installed and operated with a minimum distance of 20 cm between the radiator and your body.

Base Unit FCC ID: 2AAED-R9861521

Button FCC ID (model R9861600D01C): 2AAED-R9861600D01

ClickShare Button 2AAED-R9861600D01 has been tested and meets the FCC RF exposure guidelines. The maximum SAR value reported is 1.19 W/kg.

ClickShare button 2AAED-R9861600D01 should be installed and operated with a minimum distance of 5 mm between the radiator and your body.

## Canada, Industry Canada (IC) Notices

This device complies with Industry Canada licence-exempt RSS standard (s). Operation is subject to the following two conditions: (1) this device may not cause interference, and (2) this device must accept any interference, including interference that may cause undesired operation of the device.

## Radio Frequency (RF) Exposure Information

The radiated output power of the Barco Wireless Device is below the Industry Canada (IC) radio frequency exposure limits. The Barco Wireless Device should be used in such a manner such that the potential for human contact during normal operation is minimized.

### Caution: Exposure to Radio Frequency Radiation.

1. To comply with the Canadian RF exposure compliance requirements, this device and its antenna must not be co-located or operating in conjunction with any other antenna or transmitter.
2. To comply with RSS 102 RF exposure compliance requirements, a separation distance of at least 20 cm must be maintained between the antenna of this device and all persons.

Base Unit IC: IC: 21559-R9861521

Button IC (model R9861600D01C): 21559-R9861600D01

## IC Antenna statement

Under Industry Canada regulations, this radio transmitter may only operate using an antenna of a type and maximum (or lesser) gain approved for the transmitter by Industry Canada. To reduce potential radio interference to other users, the antenna type and its gain should be so chosen that the equivalent isotropically radiated power (e.i.r.p.) is not more than that necessary for successful communication.

This radio transmitter 21559-R9861521 has been approved by Industry Canada to operate with the antenna types listed below with the maximum permissible gain and required antenna impedance for each antenna type indicated. Antenna types not included in this list, having a gain greater than the maximum gain indicated for that type, are strictly prohibited for use with this device.

## Indoor use only warning

Operation in the band 5150-5250 MHz is only for indoor use to reduce the potential for harmful interference to co-channel mobile satellite systems.

## **Certification information (SAR)**

This device is also designed to meet the requirements for exposure to radio waves established by the Industry Canada.

The SAR limit adopted by Canada is 1.6 W/kg averaged over one gram of tissue. The highest SAR value reported to the IC for this device type complies with this limit.

The highest SAR value reported to the IC for this device type when using in portable exposure conditions is 1.14 W/kg.

## **Canada, avis d'Industry Canada (IC)**

Le présent appareil est conforme aux CNR d'Industrie Canada applicables aux appareils radio exempts de licence. L'exploitation est autorisée aux deux conditions suivantes : (1) l'appareil ne doit pas produire de brouillage, et (2) l'utilisateur de l'appareil doit accepter tout brouillage radioélectrique subi, même si le brouillage est susceptible d'en compromettre le fonctionnement.

## **Informations concernant l'exposition aux fréquences radio (RF)**

La puissance de sortie émise par l'appareil de sans fil Barco est inférieure à la limite d'exposition aux fréquences radio d'Industry Canada (IC). Utilisez l'appareil de sans fil Barco de façon à minimiser les contacts humains lors du fonctionnement normal.

### **Avertissement: L'exposition aux rayonnements fréquences radio**

1. Pour se conformer aux exigences de conformité RF canadienne l'exposition, cet appareil et son antenne ne doivent pas être co-localisés ou fonctionnant en conjonction avec une autre antenne ou transmetteur.
2. Pour se conformer aux exigences de conformité CNR 102 RF exposition, une distance de séparation d'au moins 20 cm doit être maintenue entre l'antenne de cet appareil et toutes les personnes.

IC Base Unit: 21559-R9861521

IC Button (modèle R9861600D01C): 21559-R9861600D01

## **Déclaration d'antenne d'Industrie Canada (IC)**

Conformément à la réglementation d'Industrie Canada, le présent émetteur radio peut fonctionner avec une antenne d'un type et d'un gain maximal (ou inférieur) approuvé pour l'émetteur par Industrie Canada. Dans le but de réduire les risques de brouillage radioélectrique à l'intention des autres utilisateurs, il faut choisir le type d'antenne et son gain de sorte que la puissance isotrope rayonnée équivalente (p.i.r.e.) ne dépasse pas l'intensité nécessaire à l'établissement d'une communication satisfaisante.

Le présent émetteur radio 21559-R9861521 a été approuvé par Industrie Canada pour fonctionner avec les types d'antenne énumérés ci-dessous et ayant un gain admissible maximal et l'impédance requise pour chaque type d'antenne. Les types d'antenne non inclus dans cette liste, ou dont le gain est supérieur au gain maximal indiqué, sont strictement interdits pour l'exploitation de l'émetteur.

## **Utilisation à l'intérieur seulement**

La bande 5 150-5 250 MHz est réservés uniquement pour une utilisation à l'intérieur afin de réduire les risques de brouillage préjudiciable aux systèmes de satellites mobiles utilisant les mêmes canaux.

## **Informations de certification (DAS)**

Cet appareil est également conçu pour satisfaire aux exigences concernant l'exposition aux ondes radioélectriques établies par Industrie Canada.

Le seuil du DAS adopté par le Canada est de 1.6 W/kg pour 1g de tissu. La plus grande valeur de DAS signalée à IC pour ce type d'appareil ne dépasse pas ce seuil.

La valeur maximale de DAS signalée à IC pour ce type d'appareil lors du test dans des conditions d'exposition portative est de 1.14 W/kg.

# Introduction

# 1

1.1	Versions of the product .....	24
1.2	About this guide.....	24
1.3	Symbols and fonts .....	24

## 1.1 Versions of the product

### Regional versions

Depending on the location where you buy the CX-50 product, the Base Unit and accessories are regionalized. By the time of release of this manual, 6 regional versions of CX-50 are available:

- EU
- US
- NA
- CN
- ZH
- RW



The regional version of your CX-50 cannot be changed. That means that you cannot use it in another region.

For more information on the regional variants, refer to the CX-50 Installation Guide.

### Link between Barco product brand name and the model group

CX-50 is a Barco product of the model group C 5010S

## 1.2 About this guide

### About the documentation

This user guide explains the practical use of the CX-50 .

### Available System documentation

This guide is part of the documentation set describing the CX-50 product.

Guide	Article number
User Guide	R5900095
Installation Guide	R5900096
Safety Guide	R5900094
Service Guide	R5900097
Recycling Manual	R5900029

A printed copy of the Safety Guide is included in the CX-50 box at purchase.

The User Guide describes how to use your CX-50. It also contains a basic troubleshooting part where you can search for a solution when a problem occurs.



Depending on the CX-50 version, some graphics might be different to the ones used in this manual. This however does not have any effect on the functionality.



## 1.3 Symbols and fonts

### Symbol overview

The following icons are used in the manual :

	Caution
	Warning



	Info, term definition. General info about the term
	Note: gives extra information about the described subject
	Tip: gives extra advice about the described subject

### Font overview

- Buttons are indicated in bold, e.g. **OK**.
- Menu items are indicated in *italic*.
- Step related notes, tips, warnings or cautions are printed in *italic*.
- Procedure related notes, tips, warnings or cautions are printed in **bold** between 2 lines preceded by the corresponding icon.



# Introduction to CX-50

# 2

2.1	About the CX-50 .....	28
2.2	About the Base Unit .....	29
2.3	About the Button .....	30

## 2.1 About the CX-50

### CX-50 sets

With the Conferencing Button, in seconds, you are automatically connected to cameras, mics, soundbars and any other AV peripherals in the room for a better, more immersive meeting experience. Everything becomes part of your laptop.

This CX-50 not only helps the presenter get the presentation on-screen in a second, but it also allows the other people in the conference to participate more actively. The result is enhanced meeting efficiency and better decision-making.

The set is compatible with any laptop, desktop tablet or smartphone OS. It works with most conferencing platforms and connects instantly with most brands of peripherals (speakers, microphones, webcams, soundbars) when using the Conferencing Button.

At the moment 6 different sets are available on the market. Each set is sold in its specific region and it can only be used in that specific region because of WiFi regulations.

### Components CX-50 set

A standard CX-50 set consists of a Base Unit and 2 Conference Buttons. Depending on the location where you buy the product, the software of the Base Unit is different. If needed, you can buy additional Conferencing Buttons and a tray to store the Buttons.

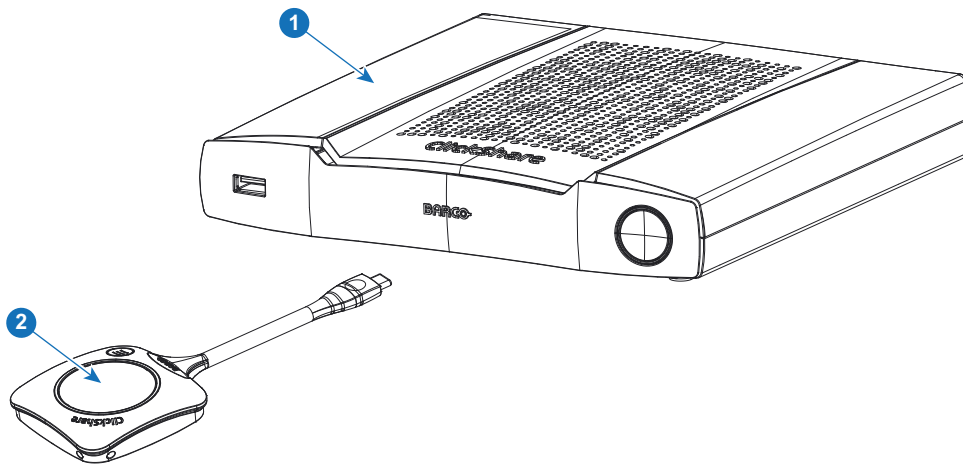

Image 2-1

- |   |                                  |
|---|----------------------------------|
| 1 | Base Unit                        |
| 2 | Conferencing Button <sup>2</sup> |

### Accessories included

Depending on the country where you buy the product, the following regionalized accessories are also included in the CX-50 box.

#### Products

R9861522xx<sup>3</sup>

#### Contains

- R9861522
- 2x R9861600D01C

#### Accessories included

- DC adapter with regional depending power cord
- Printed safety manual

R9861600D01C<sup>4</sup>1x R9861600D01C<sup>4</sup>

Contact your local sales representative for the correct regional variant to be used in your country.

2: Further called Button  
 3: xx=EU, CN, NA, US, ZH, RW,  
 4: For US, R9861600D01CUS

## 2.2 About the Base Unit

### Base Unit functionality

The Base Unit receives the wireless input from the Buttons and controls the content of the meeting room display and the peripherals connected to the Base Unit (speakers, microphones, webcam and soundbar). Furthermore, it will send out the content from the camera and/or the speakerphone towards the Button.

The Base Unit can be inside a cabinet in the meeting room, or put on the meeting room table or mounted on a wall. Check the Installation Guide for instructions on how to install the Base Unit.

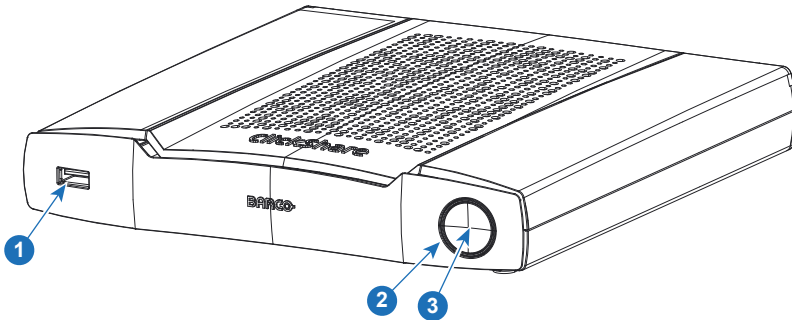

Image 2-2

1	USB Type-A port
2	Status LED ring
3	Standby Button

### USB Port

The USB port is used to pair the Button to the Base Unit and to update the software of both the Base Unit and the Buttons and to connect a touch screen, USB camera or USB echo-cancelling speakerphone to the Base Unit.

When plugging in the Button into the Base Unit, the Button is paired to the Base Unit. The Base Unit checks whether the software and firmware of the Button is up to date. If not, the Base Unit updates the software and/or firmware.

Use a convertor to connect a Button with an USB Type-C™ connector to front USB port of the Base Unit. USB Type-C™ port available at the backside.

### Status LED ring

The color of the LED ring around the power button of the Base Unit give information on the status of the system.

LEDs behavior	Explanation
static red	<ul style="list-style-type: none"> <li>receiving content from the Buttons and streaming towards the display.</li> <li>during the first phase of the Base Unit boot process.</li> </ul>
blinking white	<ul style="list-style-type: none"> <li>system is starting up (during the second phase)</li> <li>Button pairing is in progress</li> <li>software update of the Base Unit</li> </ul>
breathing white	<ul style="list-style-type: none"> <li>ECO standby mode</li> </ul>
static white	<ul style="list-style-type: none"> <li>awake and ready (i.e. showing the welcome message on the display)</li> <li>pairing and software update of the Button is done, you can now unplug the Button from the Base Unit.</li> </ul>

LEDs behavior	Explanation
red blinking	<ul style="list-style-type: none"> <li>an error occurred</li> </ul>
dark	<ul style="list-style-type: none"> <li>deep standby/off</li> </ul>

## Power button

The button at the front of the Base Unit has a standby function once the Base Unit is powered.

- When the system is in normal operational mode, a push makes the system go into a pre-defined standby mode.
- When the system is in standby, a push triggers the system to start up and it goes into normal operational mode.

## 2.3 About the Button

### Button layout

A Button consists of five main components

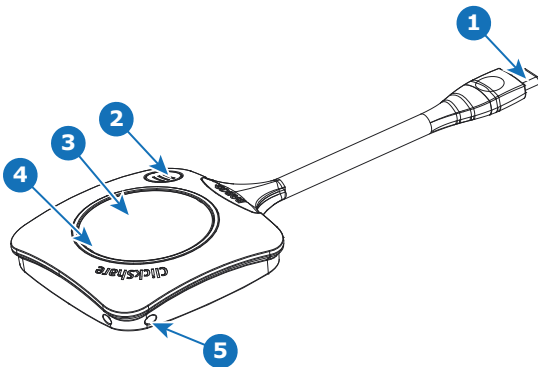

Image 2-3

1	USB Type-C™ connector
2	Quick access button
3	Button
4	LED ring
5	Strap hole

### USB connector

Using the USB connector the Button can be plugged into a laptop (for sharing your screen) or the Base Unit (for pairing the Button to the Base Unit or updating its software). Button R9861600D1C has a USB Type-C™ connector. Depending on the type of USB port on your laptop or on the Base Unit a convertor must be used.

### Button

By inserting the Button, the peripherals attached to the Base Unit can be used in the tool of your preference. Click the Button to display the content of the laptop's screen on the meeting room display. Clicking the Button during the meeting will toggle the sharing of the screen. Click the small button to get additional functionality and controls.

### LED ring

The LED ring indicates the current status of your ClickShare.

LEDs behavior	Explanation
white ring filling up	<ul style="list-style-type: none"> <li>• Button is plugged in the laptop and initializing.</li> <li>• Button is updating/pairing</li> </ul>
green ring	<ul style="list-style-type: none"> <li>• pairing and software update is done. You can now unplug the Button from the Base Unit.</li> </ul>
spinning white circle	<ul style="list-style-type: none"> <li>• Button is busy (no end time known).</li> <li>• ClickShare App is setting up the connection with the Base Unit.</li> </ul>
white blinking	<ul style="list-style-type: none"> <li>• the Button is waiting for the user to start the ClickShare application.</li> </ul>
static white	<ul style="list-style-type: none"> <li>• ClickShare is ready to start sharing your screen.</li> </ul>
static red	<ul style="list-style-type: none"> <li>• sharing your screen with the display<sup>5</sup>.</li> </ul>
red blinking	<ul style="list-style-type: none"> <li>• an error occurred.</li> </ul>
off (no light)	<ul style="list-style-type: none"> <li>• the Button is not or not properly inserted into the USB port.</li> <li>• the Button might be defective.</li> <li>• the USB port or computer might be defective.</li> </ul>

5: While sharing content, the laptop will not go to standby. Once sharing is stopped, the laptop will again be capable of going to standby.





# Getting started

# 3

3.1	Activating the Base Unit .....	34
3.2	Basic Use, with Button .....	34
3.3	Basic Use, with ClickShare desktop app .....	37
3.4	User Interface .....	40
3.5	Extended desktop .....	41
3.6	Share an application .....	42
3.7	Microsoft Office PowerPoint Presenter mode .....	44
3.8	View room display .....	44
3.9	Stop sharing and leave .....	45
3.10	Audio configuration .....	45
3.11	Pairing .....	46
3.12	Touch Back .....	47
3.13	Room Dock .....	48
3.14	Airplay .....	48
3.15	Chromecast .....	48
3.16	Miracast.....	49

## 3.1 Activating the Base Unit

### About power mode

The Base Unit is powered via an external power adapter. Once connected, the Base Unit is automatically switched in standby mode. For more information about power connection, see CX-50's installation manual.

### Standby button

1. Push the button shortly.

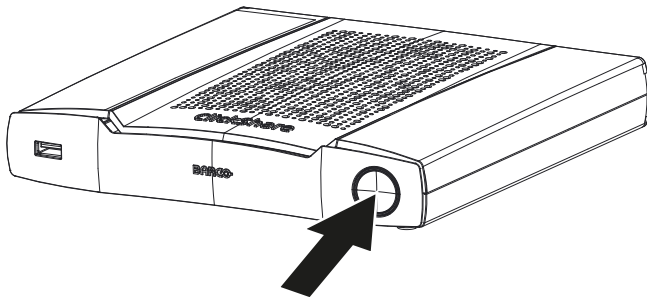

Image 3-1 Standby button

When the Base Unit was on, it goes to standby.

When the Base Unit was in standby, it starts up.

## 3.2 Basic Use, with Button

### Basic functionality

When entering a meeting room equipped with ClickShare and if the display is not in screensaver mode, the ClickShare wallpaper is shown on the display. The content of the wallpaper depends on the setup. Connected peripherals to the Base Unit and their status are indicated on the wallpaper.

Starting to use ClickShare is now very simple.

### To start using CX-50 with a Button

1. Take a Button and insert the Button into a USB port of your laptop. Depending on the USB port on your laptop a convertor must be used. This convertor is not delivered by Barco.

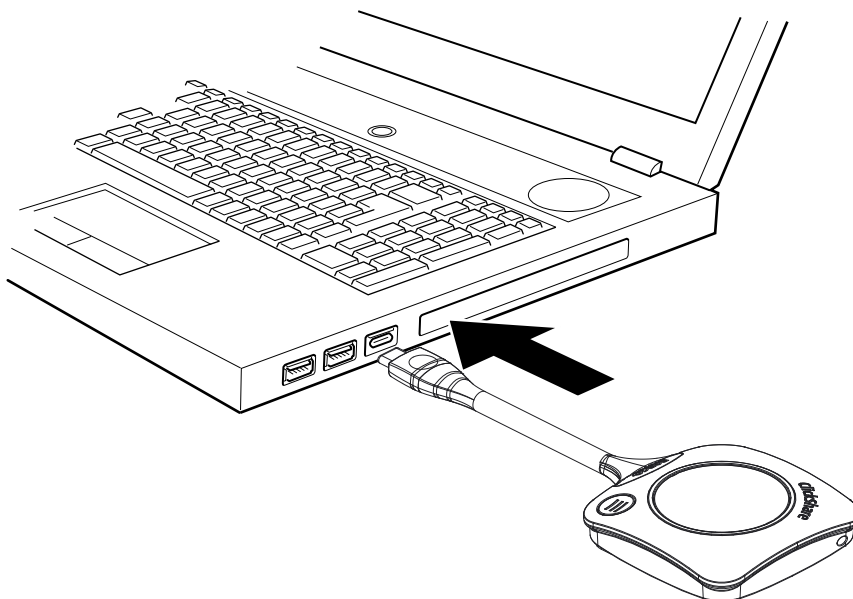

Image 3-2

The white ring on the Button is filling up. When totally filled up it goes to static white and is ready to share or it starts blinking to indicate that you have to start clickshare.exe on your computer.

On your laptop a new drive appears.  
Different situations are possible now:

- Nothing installed, LED ring fills up and starts flashing, indicating that the executable needs to be started by the user. Double-click the ClickShare application.
- For Windows environment: when connected to internet, driver will be installed and the executable will be started by the driver.
- For Mac environment: CD-ROM drive will appear, open it and launch the application to get started.
- A launcher or the ClickShare desktop app is preinstalled on your laptop (downloaded from the Base Unit or Barco website, or deployed company-wide by your IT department). ClickShare is immediately available. You can continue with go to step 2.

## 2. The application is started



The icon appears in the system tray.

When the system is ready for use, a message appears close to the systray icon. Message is as follow:  
Ready to share to <ClickShare name>

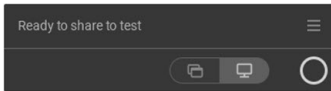

Image 3-3

The LEDs of the Button are static white.

The peripherals such as USB camera, echo cancelling audio device, etc. can now be used in the tool of your preference on your device.

Your screen or a typical application can be shared.

## 3. To share your screen on the display, click the Button.

The LEDs of the Button become static red and your screen appears on the display. When audio is enabled on the ClickShare Base Unit, the audio of your laptop is also available on the audio output of the Base Unit, and it will be played via the meeting room audio system. The icon returns to the same state as in step 3.

When a USB echo cancelling audio device is connected to the Base Unit, all audio, content audio and speaker audio is played via the speakerphone system.



The Ready to share message is reduced to to a red icon

ClickShare automatically scales the content of your screen to the resolution of the meeting room display. The aspect ratio of your screen is maintained to make sure the proportions are correct.

## 4. To freeze the content on the screen while you look up something on your PC, just click on freeze icon (1) next to the ClickShare icon. The icon will change to a release icon (2)

To resume the content sharing, click on the the release icon (2).

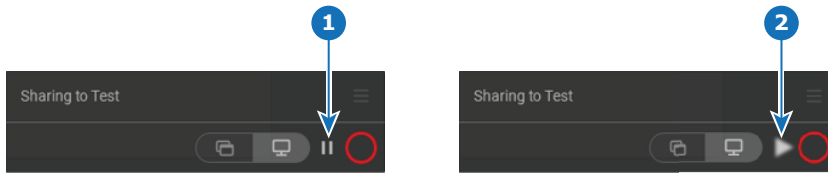

Image 3-4

5. To remove your content from the display, click the Button again.  
The LEDs of the Button become static white.
6. When leaving the meeting room, unplug the Button from your laptop.  
No trace of the ClickShare application is left on your laptop.



As second user can replace the current presenter with a long press on his Button.

### Use in a fully equipped conference room

When connecting with the Button, it allows you to connect the room speakerphone, microphone and camera wireless to your laptop and use the better equipment of the room in your video conferencing call.

Icons on the wallpaper indicate the availability and status of the peripherals in the room. When one of them is not attached to the Base Unit allowing to create an audio only meeting room or a video only meeting room, the corresponding icon will not be shown on the wallpaper.



Image 3-5

- |   |  |
|---|--|
| <p><b>A</b> No peripherals attached, local view active</p> <p><b>B</b> Camera and speakerphone attached, only local view active</p> <p><b>C</b> Camera and speakerphone attached and active, local view active</p> <p><b>1</b> Local view active</p> <p><b>2</b> Camera connected, not active</p> | <p><b>3</b> Speakerphone connected, not active</p> <p><b>4</b> Local view active</p> <p><b>5</b> Camera connected and active</p> <p><b>6</b> Speakerphone connected and active, not muted.</p> <p><b>7</b> Local view active</p> |
|---|--|

### Quick access button

This quick access button opens a selection window to make the choice what will be displayed on the screen.

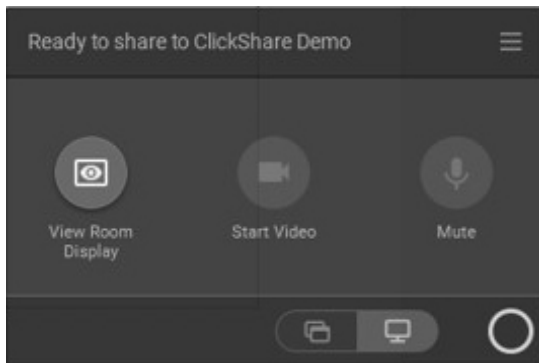

Image 3-6

Examples of some choices are:

- View the room display
- Start video
- Mute micro

## 3.3 Basic Use, with ClickShare desktop app

### About the ClickShare desktop app

With the ClickShare desktop app installed on your computer you can enter a meeting room and get on the screen in a few seconds.

The ClickShare desktop app connects to the meeting room screen in order to share your content. Presence detection technology is used to do so. The ClickShare desktop app uses Wi-Fi beacons and an inaudible audio signal to detect the most nearby meeting rooms and show a list of maximum 5 most nearby meeting rooms, sorted based on signal strength on your computer. Just click on your meeting room name. This means you will never have to enter IP addresses or scroll long lists of meeting rooms before being connected to your meeting room.

The ClickShare desktop app can be used with or without a Button.

### ClickShare desktop app installation

When the ClickShare desktop app is not pre-deployed in your IT environment, you can download and install the software without administrator rights from [www.clickshare.app](http://www.clickshare.app).

### How to use

1. Enter a meeting room.

The ClickShare desktop app will list up to 5 most nearby meeting rooms and sort them based on the signal strength.

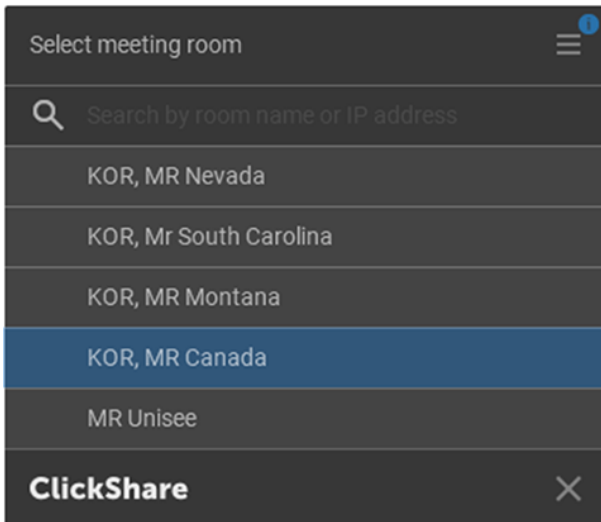

Image 3-7 Meeting room list

2. If the use of a pin is enabled on the Base Unit, the ClickShare desktop app will prompt you to enter the pin that is shown on the meeting room screen.

Enabling the pin on the Base Unit (this can be done in the ClickShare Configurator) provides an additional layer of security. This way you will never share your content to the wrong meeting room screen.

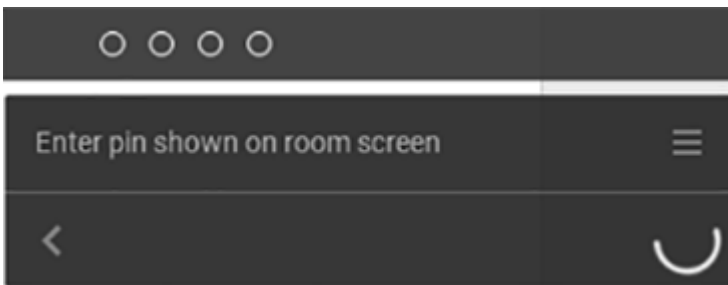

Image 3-8 Enter pin

After having entered the pin, the ClickShare desktop app will connect to the meeting room.

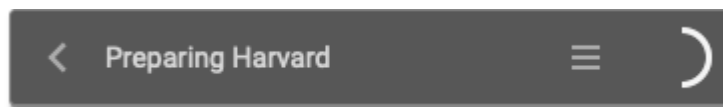

Image 3-9 Prepare connection

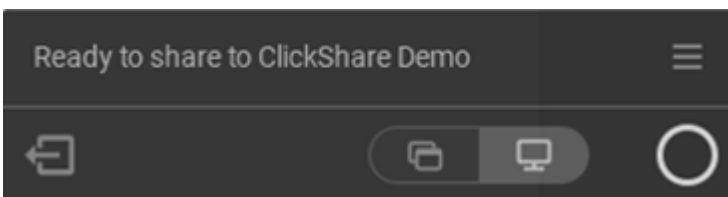

Image 3-10 Ready to share

3. Click the white circle to start sharing your content.

When the sharing is started, the ClickShare desktop app will minimize to the side through an animation. A subtle red bar remains visible on your screen.

Hover over the red bar on the side to open the full interface of the ClickShare app. to either pause your sharing session and freeze the content on the screen while you work on your laptop (invisible for people in the meeting room), to change what you are sharing (a single application or your full screen) or to stop sharing (by clicking on the red circle).



Image 3-11

4. Stop sharing by hovering over circle and clicking on the full red circle.

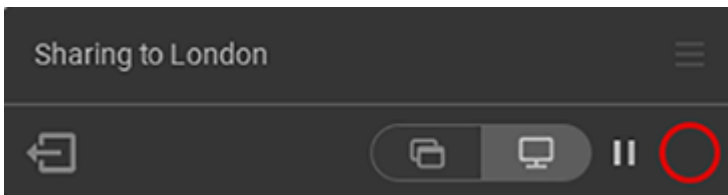

Image 3-12

5. Disconnect from the meeting room by clicking the “leave room” icon

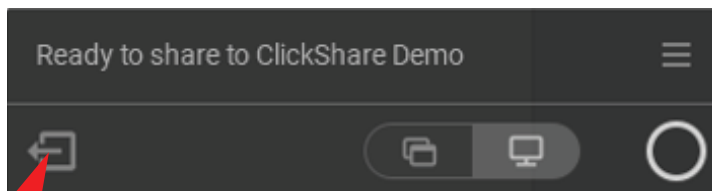

Image 3-13 Leave meeting room

or

when you walk away from the meeting room the app will show a message indicating you probably left the meeting room and you are still connected to the screen.

### ClickShare Desktop app in a conference room

When connected to a meeting room using the ClickShare desktop app that is enabled for use with ClickShare Conference you might receive a notification upon connection, notifying you that a ClickShare Button is required to use the wireless conferencing capability. This notification will only be shown the first 5 times you connect with the ClickShare Desktop App to a wireless conferencing enabled meeting room. The notification can be dismissed by clicking the button **OK, Got it**.

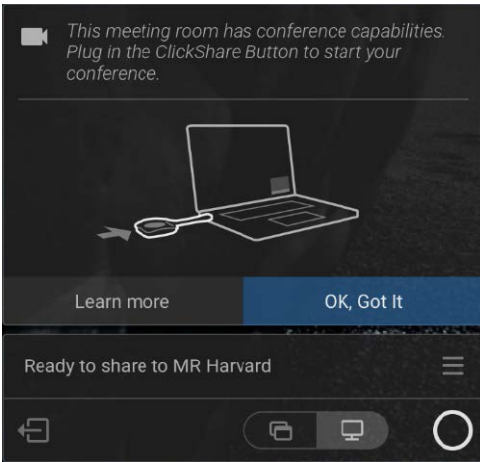

Image 3-14 Conference room message

Limitations when not using the ClickShare Button to connect:

When connected using the ClickShare Desktop App, without the ClickShare Button plugged-in, your experience is limited to the collaboration capabilities available on ClickShare. You will not be able to use the room camera, room speakers, microphone or speakerphone for wireless conferencing until a ClickShare Button is plugged-in.

### Joining a conference

When using Outlook for creating appointments or invites, you will get an immediate overview in the ClickShare Desktop app of your next meetings.

Just click to join your next conference call whether in Teams, Zoom or WebEx. The appropriate application will open automatically.

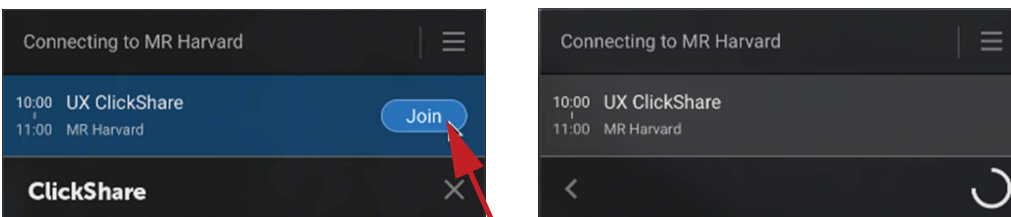

Image 3-15

## 3.4 User Interface

### User Interface functionality

When a Button is plugged in or the ClickShare desktop app is running and ready for sharing (not sharing yet), additional functionality (context menu) can be selected via the hamburger menu icon.

### Context menu

1. Click on the menu icon on the Ready to share message.

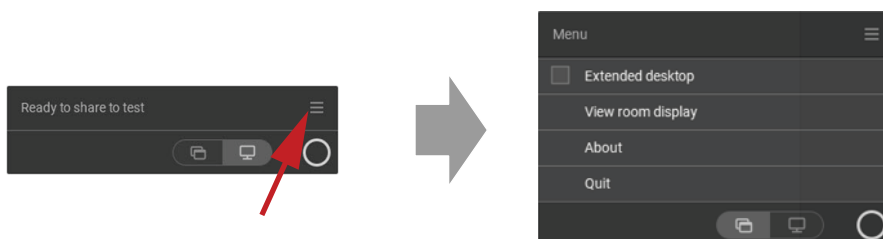

Image 3-16

The context menu appears.



- From the list, click the action you want to perform.

## 3.5 Extended desktop

### About extended desktop

Depending on your selection, your primary screen or your extended screen will be captured and displayed via ClickShare. That extended screen can be a physical screen or a virtual screen.

The use of the extended desktop functionality does require the extension pack to be installed on your device. More information on the extension pack can be found on the ClickShare Extension pack product page (<https://www.barco.com/en/product/clickshare-extension-pack>).

With extended desktop you can take advantage of both your laptop screen and the central meeting room display. Presentation notes or other material on primary screen will not be displayed to everyone (so-called PowerPoint Presenter mode) or when you want to take notes whilst sharing something else..

Note that the Presenter mode can also be achieved without the use of the extended desktop and one can also choose to share only the application you wish to share in the room via the sharing mode toggle (see “Share an application”, page 42).

PC with virtual extended screen:



Image 3–17

Primary screen displayed on the PC, extended screen displayed on the meeting room display.



Image 3–18

PC with one extended screen connected. That extended screen will be captured and displayed on the meeting room display.



Image 3-19

PC with two extended screens connected. The first extended screen, screen 2 will always be captured and displayed on the meeting room display.

### How to select

1. Click on the menu icon of the Ready to share message.

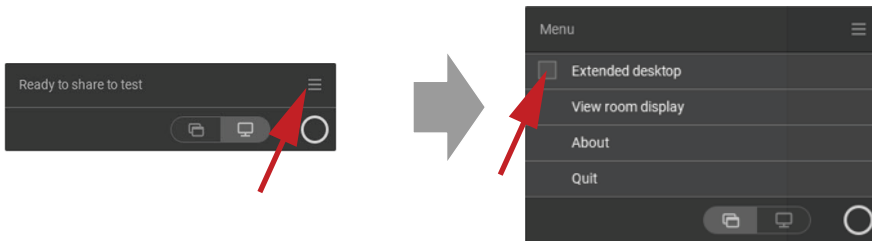

Image 3-20

The content menu opens.

2. Check the check box before Extended desktop.

## 3.6 Share an application

### About sharing an application

When *Share an application* is selected, you will be presented with an overview of open applications on your computer. Once you select an application to share, only this application will be shared on the big screen

### How to select via the content menu

1. Click on the share application icon of the Ready to share message when a Button is plugged in or the ClickShare desktop app is ready to share..

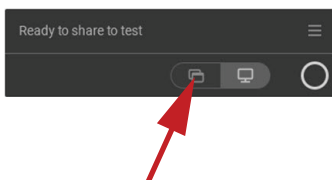

Image 3-21

The last 6 open applications on your computer are displayed.

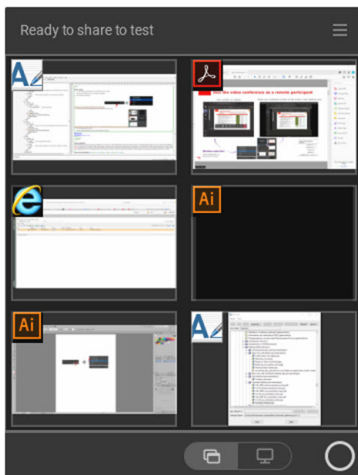

Image 3-22

2. Hover your mouse over the application to share. That window becomes blue.
3. Click on that application to select.  
Only the selected application is shared on the meeting room display.

### Via the Quick access button

1. Push the quick access button and click on the *share an application* icon.

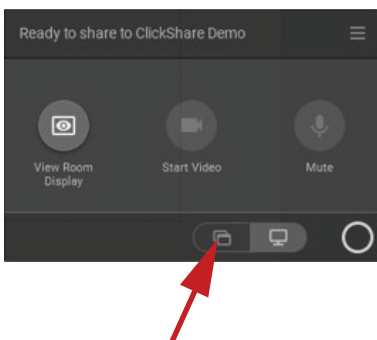

Image 3-23

2. To display an application, select *Share an Application*.  
The last 6 open applications on your computer are displayed.

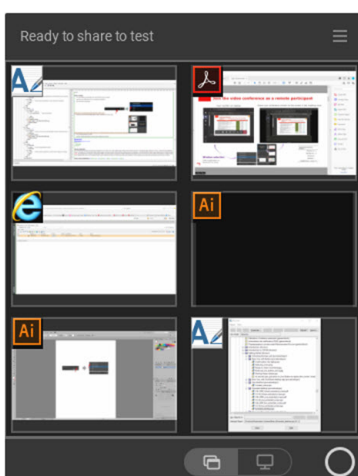

Image 3-24

3. Hover your mouse over the application to share. That window becomes blue.

4. Click on that application to select.

Only the selected application is shared on the meeting room display.

## 3.7 Microsoft Office PowerPoint Presenter mode

### Overview

To view your speaker notes on your pc when sharing a presentation on the room display, one can make use of the PowerPoint Presenter mode functionality in Microsoft Office PowerPoint without the need for a second (virtual) display.

When sharing a Slide Show using Share an application you will be reminded of the Presenter Mode functionality through a useful notification. This notification remains on screen for 10 seconds and is only shown the first five times you share a Slide Show.

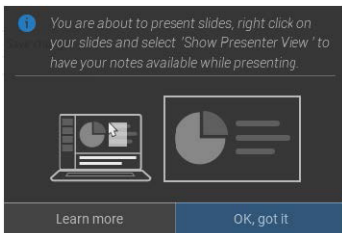

Image 3–25

### Presenter mode on Windows

1. Open your PowerPoint and start your Slide Show. This will show your presentation full screen on your PC.
2. With a Button plugged in or the ClickShare app ready to share, select *Share an application* from the hamburger menu.  
An overview of the current available application on your laptop will be displayed;
3. Select the PowerPoint Slide Show to share to the meeting room display.
4. On the full screen presentation, right-click on the slide and select Show Presenter View to see speaker notes while sharing the Slide Show to the meeting room display

### Presenter mode on macOS

1. Open your PowerPoint and start your Slide Show
2. With a Button plugged in or the ClickShare app ready to share, select *Share an application* from the hamburger menu.  
An overview of the current available application on your laptop will be displayed;
3. Select the PowerPoint Slide Show to share to the meeting room display
4. Right-click on the slide and select Use Presenter View to see speaker notes while sharing the Slide Show to the meeting room display

## 3.8 View room display

### About view room display

When connected to a Base Unit, you can access the content which is shown on the meeting room display by selecting *View room display*. When doing so, a new window will open in which you will find an exact copy of what is on the meeting room display. This is useful when e.g. sitting in the back of the room, when you are taking meeting notes or when you wish to share what is shown in the room (by yourself or others) to remote participants in a UC&C call.

## How to view

1. With a Button plugged in or the ClickShare desktop app ready, click on the hamburger menu and select View room display.

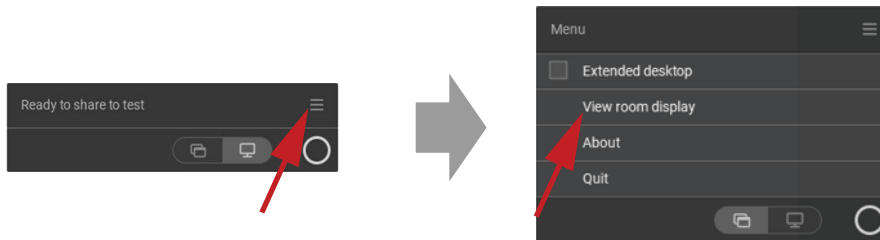

Image 3-26

The content of the meeting room display is transferred to a new window on your laptop. A red eye will be shown at the bottom left on the meeting room display splash screen.



Image 3-27

## 3.9 Stop sharing and leave

### With the ClickShare desktop app

When your meeting has come to an end, stop sharing by hovering over the red bar to expand the interface and clicking the full red circle.

Disconnect from the meeting room by either clicking the “leave room” icon (see below) or by simply closing your laptop.

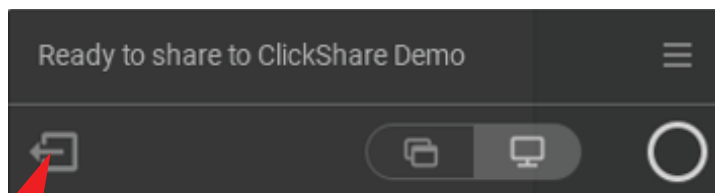

Image 3-28 Leave meeting room

### With a Button

Click the Button and unplug the Button from your laptop.

## 3.10 Audio configuration

### Audio configuration

The connected user must control his own audio signal using the audio configuration of his computer. If he does not want to broadcast his audio signal, he has to mute audio on his computer.

For some operating system, it is necessary to set ClickShare as your default output device. Once you unplug the Button, the default setting is switched back to the previous setting. The speakerphone selection is also selected.

### Audio configuration

The following configuration is the expected configuration for the playback devices when plugging the Button. ClickShare speaker as default device and room speakerphone as default communications device.

The speakerphone is available and can be used even when not on screen. The sound coming out of the speaker is only heard when sharing content. With this defaults, the content audio will be played by the speakers and communication clients (UC&C and conferencing tools) will use the room speakerphone. For best experience, the room speakerphone should be selected in the communications client at all times. Difference is that the audio from the Speakers will be lip-synced with the content, but will have higher latency. The communications device is optimized for the lowest latency possible, but no lip-sync is guaranteed with the video. For an optimal conference, the audio should always be transferred with lowest latency possible and will get priority over video.

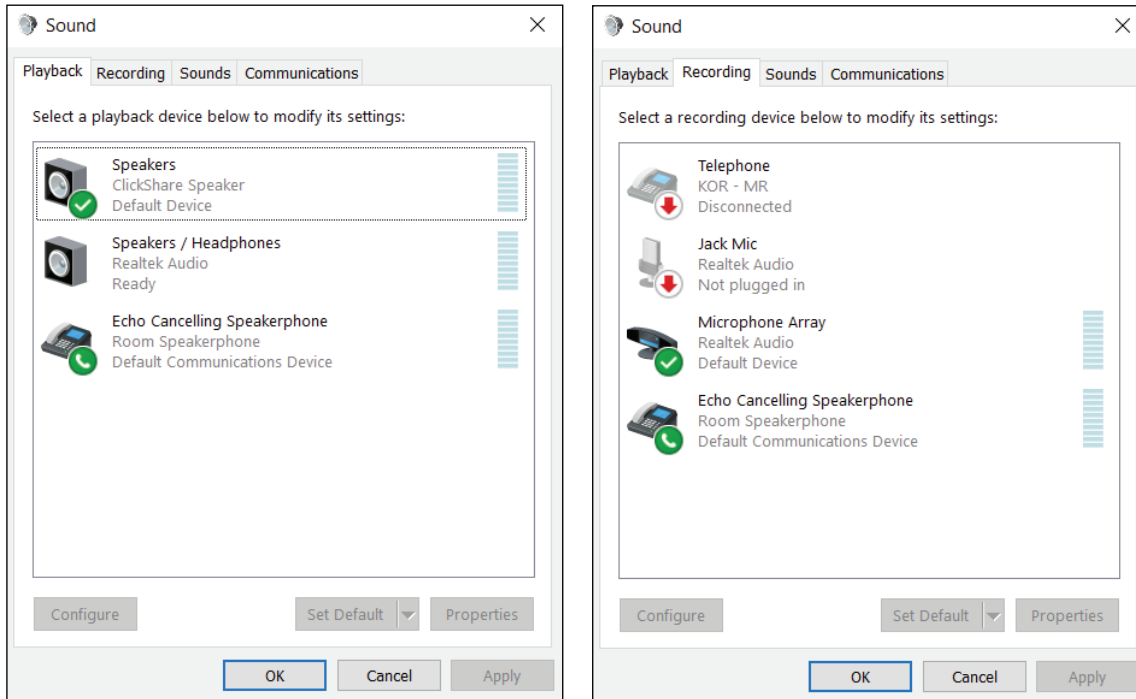

Image 3–29 Audio setup

## 3.11 Pairing

### Pairing of the Buttons with the Base Unit

To be able to use a Button it should be assigned to the Base Unit you are using. This process is called pairing. All Buttons will need to be updated and paired before use.

In case you buy additional Buttons or when a Button should be assigned to another Base Unit, the Button needs to be paired (again). The Button software update runs in the background and will not impact users while using the system. When downgrading or updating to an older version of the Base Unit software the Button need to be paired manually to update their software.



A Button can only be paired to one Base Unit at a time.  
The Button will always make connection to the Base Unit it was last paired to.

Pairing a Button can be done in two ways:

- by plugging the Button to the Base Unit.
- by using the Button Manager application running on your laptop.

### To pair a Button to the Base Unit by plugging in

1. Insert the Button in one of the USB port available on the Base Unit you are using (image is only given as example, all USB connectors can be used).



*Note:* For some ports or Buttons, it can be necessary to use a convertor.

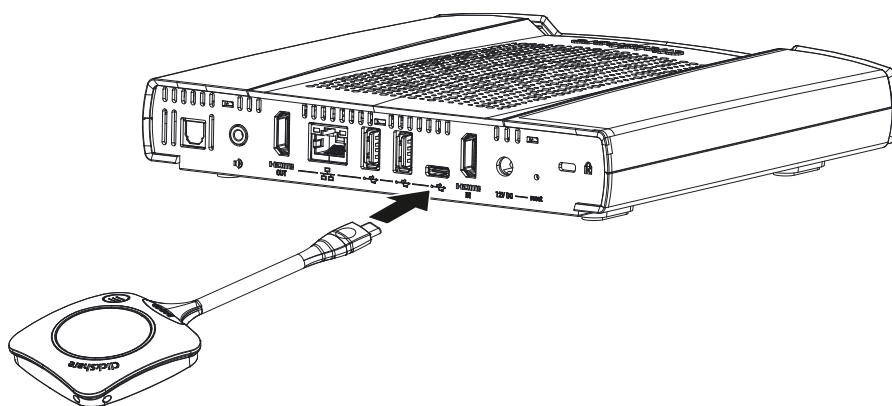

Image 3-30 Pair Button

The Base Unit LED is blinking while the Button LED fills up a circle. This means pairing is in progress.

The Base Unit automatically checks whether the software of the Button is up to date. If not, the Base Unit updates the Button software. This may take more time.

The result of the pairing process can be as follows:

- When the LEDs on the Button become green and on static white on the Base Unit, the Button is paired to the Base Unit. You can unplug the Button from the Base Unit.

## 2. Unplug the Button from the Base Unit.

The Button is now ready for use.



Image 3-31

## 3.12 Touch Back

### About Touch Back

Touch Back support on your wireless collaboration solution allows you to control any application on your laptop via the touch screen in the room, instead of using a computer mouse or clickers. You can control data with your finger or with a specified stylus. Stay in control of your presentation, and don't let technical limitations interrupt the flow of your meeting anymore.

No need to go back to your laptop or use unreliable clickers to move to the next slide. Simply tap the screen to switch slides. And with a few touches on the screen, you can also open other presentations, share mails or start a video. With one tap on a touch screen, you can also select the blackboarding or annotation functionality. The combination of a touch display and a wireless collaboration tool drives the productivity and engagement in your meeting room.

- It gives you the opportunity to present more freely within the meeting space
- You can start to ideate on content real-time.
- Collaborate more interactive and creatively.
- Get higher engagement from the participants.
- Technical limitations of the room are not hindering the flow of the presentation or meeting.
- It boosts spontaneous collaboration, giving people the opportunity to use the specific extras like easy access to online content, cloud drives or photos, zoom, annotate, blackboarding...

### What you need to use Touch Back

- You need a Button successfully paired and updated with the corresponding Base Unit.

- A supported touch panel display. A list of supported displays is listed on Barco's website in "*The ClickShare Supported Touch Panels Whitepaper*".

## How to use Touch Back

- Tap once to control your laptop instead of using the computer mouse.
- To right-click, the touchscreen needs to be pressed for about 2-3 seconds long.
- Touchback can be enabled/disabled by touching the icon on the bottom right on the meeting room display

## Points to know

- The best performance is achieved by sharing without audio.
- When sharing the extended desktop, a small lag might be observed.
- Native touchscreen functionalities cannot be used in combination with Touch Back. Ideally, they need to be disabled.

## 3.13 Room Dock

### About

Room Dock allows to create a wireless bridge for echo-cancelling speakerphone and USB camera attached to the Base Unit. This allows the user to take advantage of the installed meeting room peripherals to have better audio and video conferencing using their typical videoconferencing tools like Skype or Zoom.

The echo-cancelling speakerphone and USB camera is accessible to any user that has a Button plugged in.

## 3.14 Airplay

### About Airplay

Airplay is a protocol that allows wireless streaming between devices of audio, video, device screens and photos. The ClickShare Base Unit can be configured to receive the airplay streaming

### Why Airplay

You want to show multiple people your photos and videos or your PowerPoint and Keynote presentation on a big screen? Connect your device to the ClickShare Base Unit which can be configured to receive the Airplay streaming.

### How to use Airplay

1. Make sure your device is connected with the ClickShare WiFi in the meeting room.
2. Open the control panel of your device and swipe up from the bottom left of the screen or swipe down from the top right of the screen, depending of your device.
3. Click on  Synchronise display and select the ClickShare device in the meeting room.

For more information about using Airplay with a typical device, consult the user manual of that device.

## 3.15 Chromecast

### About Chromecast

Chromecast is a protocol that allows wireless streaming between devices of audio, video, device screens and photos. The ClickShare Base Unit can be configured to receive the Chromecast streaming.

### Why Chromecast

You want to show multiple people your photos and videos or your PowerPoint and Keynote presentation on a big screen? Connect your device to the ClickShare Base Unit which can be configured to receive the Chromecast streaming.



## How to use Chromecast

1. Make sure your device is connected with the ClickShare WiFi in the meeting room.
2. Click on the cast-icon to display the content of your device on the meeting room screen.

For more information about using Chromecast with a typical device, consult the user manual of that device.

## 3.16 Miracast

### About Miracast

Miracast enables seamless display of multimedia content between Miracast devices. Miracast allows users to wireless share multimedia, including high-resolution pictures and high-definition (HD) video content between Wi-Fi devices, even if a Wi-Fi network is not available. Miracast creates its own direct wireless signal between your mobile device and the wireless display receiver (ClickShare Base Unit).

### How to use Miracast

1. Miracast should be enabled on the ClickShare Base Unit.
2. Your mobile device needs to be Miracast enabled. Devices like Samsung smartphones or other Android phones, as well as devices that use Windows 8 or 10, typically have the technology built-in.
3. In the settings of your mobile device, open 'wireless display' (name can be different depending on the device type and model). See the device's user guide.
4. Select the ClickShare Base Unit in the meeting room.



# Troubleshooting

# 4

## 4.1 Basic troubleshooting

### Problem solving

In this chapter some problems that might occur while using CX-50 are listed. For each problem possible causes are given and a solution is proposed. If you cannot solve the problem yourself, please contact your local IT administrator.

### Generic issues

Problem	Cause	Solution
Your screen is not shown on the display when pressing the Button.	Wrong input is selected on the display.	Select the correct input on the display or on the room control system
	Base Unit in standby	Briefly push the standby button on the Base Unit or plug in a Button and run the ClickShare client software.
	You are the third person that wants to share the content to the display.	The first or second user has to push his button to remove his content so that a third user can share his content. or As third user, click and hold the Button to use the Show me function of ClickShare.
	The ClickShare client software is not running.	Go to the ClickShare drive and run the software.
Your screen is shown, but your audio is not playing on the meeting room audio system	Your audio signal on your PC is muted	Right click on the speaker icon and switch off the mute.
	Audio system of the meeting room is not switched on	Switch on the audio system of the meeting room.
	When using separate audio, audio cable is not connected	Check audio connection between the Base Unit (audio out, green connector) and the audio system of the meeting room.
	Default speaker is not correctly set	With a Button inserted, set ClickShare speaker as your default speaker.
	Buttons are not re-paired after changing the audio setting on the web interface	Re-pair the buttons.
	Audio setting on the web interface is not correctly set.	Consult your administrator to select the correct audio setting.
Your content is removed from the display and the LEDs of your Button are blinking white.	Connection to the Base Unit has been lost.	ClickShare tries to restore the connection automatically. If this fails, the LEDs of the Button start blinking red. You should unplug the Button from your laptop and start a new.
Nothing is shown on the display at all.	The display is switched off.	Switch on the display.
	Wrong input is selected.	Select the correct input.
	The display cable is not connected (correctly).	(Re)insert the display cable to the display and the Base Unit.

Problem	Cause	Solution
	The display does not recognize or is not able to display the Base Unit output resolution.	You or an administrator should change the corresponding setting via the web interface.
	The Base Unit is in standby mode.	Briefly push the standby button on the Base Unit or plug in a Button and run the ClickShare client software.
	The Base Unit is powered off.	Check if power adapter is connected to the Base unit and to the wall outlet.
	Wallpaper is disabled	If you connect a Button and start sharing, the content should be shown.
After inserting the Button into your laptop, you cannot find the ClickShare drive.	No automatic refresh of drives.	Refresh the view on your laptop.
	Bad connection at USB port on laptop.	<ul style="list-style-type: none"> <li>Reconnect to the USB port.</li> <li>Try another USB port.</li> <li>Reboot your laptop.</li> </ul>
	Windows tries to assign the ClickShare drive to an already reserved drive letter	Use Microsoft Windows Disk Management to assign it to a free drive letter.
	IT policy not mount USB drives	Contact your IT responsible.
Some programs of Windows are not shown on the display.	Use of overlays, 3D or hardware acceleration in the GPU.	<ul style="list-style-type: none"> <li>Disable overlays or hardware acceleration in the GPU.</li> <li>Disable AeroGlass in Windows 7</li> <li>Capture mode</li> </ul>

### Issues related to first time use and updating

Problem	Cause	Solution
Ethernet cable is inserted, but the Base Unit does not receive an IP address	Fixed IP address not configured. 802.X authentication required	Contact your IT responsible
Update server not reachable	Proxy server to be configured. Firewall is blocking the connection	Contact your IT responsible
Buttons do not connect after first time installation	Buttons not paired	Please pair the Buttons by plugging them into the USB ports of the Base Unit. Manual pairing only needs to be done once, after this, the Buttons will be automatically updated when updating the Base Unit
Unable to connect to internet	No internet available at the customer's site	Contact your IT responsible

### Issues related to screen sharing (video/screen sharing)

Problem	Cause	Solution
After inserting the Button into your laptop, you cannot find the ClickShare drive.	Bad connection at USB port on laptop	Reconnect to the USB port, try another USB port, or reboot your laptop.

<b>Problem</b>	<b>Cause</b>	<b>Solution</b>
	Windows tries to assign the ClickShare drive to an already reserved drive letter	Use Microsoft Windows Disk Management to assign it to a free drive letter.
	Bad block on the mass storage	Please re-pair the Button with the Base Unit to restore the flash
I cannot start the ClickShare App	Running 3rd party applications is blocked by IT	Contact your IT responsible. In the meantime, you can share your screen using your device's native protocols
	You are using a Linux PC or ChromeBook	Use the device's native protocols to share on screen
Button LEDs are blinking	Clickshare Application has not been started	Start the application on the ClickShare Button's mass storage or download and run the ClickShare Desktop App.
Screen is not shown when pressing the Button although Button LED is static white.	Already two people on screen	Long press the Button to kick off all other sources from screen. Or ask for somebody to remove its source from screen
	Somebody is moderating the session	Request the moderator to put you on screen or claim the moderation role from the ClickShare application
Your shared content becomes grayed out.	Connection between the ClickShare application (or Button) and the Base Unit is lost	ClickShare tries to restore the connection automatically. If this fails, the LEDs of the Button start blinking red. You should unplug the Button from your laptop and start a new
Button cannot connect to the Base Unit. Button LEDs keep spinning.	Button is not paired to correct Base Unit.	Pair the Buttons with the Base Unit
	Base Unit settings have changed and Button has not been paired again.	Pair the Buttons with the Base Unit.
When network integrated, the Button cannot find the Base Unit.	IP address of the Base Unit has changed.	Pair the Buttons with the Base Unit.
	The Button cannot connect to the Base Unit due to firewall settings.	Contact your IT responsible.
Quality of the image displayed is not satisfactory.	Button is using a channel with high utilization.	Contact your IT responsible.
	Base Unit antennas are obstructed.	Make sure no insulation or metal plating or a cage is placed around the Base Unit. If too far, place the Base Unit closer to the location of the Buttons. Preferably, have line of sight between Base Unit and Button.
	Low signal strength	Place the Base Unit closer to the location of the Buttons. Check the settings of the Base Unit to see if the power of the wireless signal has not been set too low.

Problem	Cause	Solution
	Laptop performance	<p>If the video performance is acceptable with a higher performing laptop, laptop performance might be the cause of bad video playback. To reduce the load on the laptop, you can:</p> <ul style="list-style-type: none"> <li>• Lower the resolution of the laptop screen</li> <li>• Use application sharing in the ClickShare app to only share a part of the screen.</li> <li>• Disable hardware acceleration for video.</li> <li>• Disable extended screen sharing</li> </ul>
Some programs of Windows are not shown on the display.	Use of overlays, 3D or hardware acceleration in the GPU.	<p>Disable overlays or hardware acceleration in the GPU. In Windows 7, disable AeroGlass.</p>
Unable to share from extended desktop.	Mac OS	<p>The Clickshare Extension pack only works with Windows. This feature is available to Mac users through Airplay. An alternative is to use the Window sharing functionality in the ClickShare Desktop App</p>
	Extension pack not installed	<p>In order to have a second screen on your computer when using ClickShare, you will need to download and install the ClickShare extension pack. <a href="http://barco.com/clickshare/extensionpack">barco.com/clickshare/extensionpack</a></p>
	Old Extension pack installed	<p>ClickShare will only work with the latest version of the Extension Pack. Please uninstall the extension pack and install the latest version. <a href="http://barco.com/clickshare/extensionpack">barco.com/clickshare/extensionpack</a></p>

### Issues related to screen sharing (audio of shared content)

Problem	Cause	Solution
Your screen is shown, but your audio is not playing on the meeting room audio system.	Your audio signal on your PC is muted.	Right click on the speaker icon and switch off the mute.
	Audio system of the meeting room is not switched on or not connected.	Switch on the audio system of the meeting room. Check audio connection between the Base Unit and the audio system of the meeting room.
There is no ClickShare audio device for me to select on my computer.	Audio output of the Base Unit is not correctly configured.	Ask your administrator to configure audio of the Base Unit.
	Audio device is not available in my OS when I plug in the Button after	Re-pair the Buttons with the Base Unit.

Problem	Cause	Solution
	changing audio settings on my Base Unit.	
ClickShare audio device is visible, but sound is coming out of my own device or other audio device connected to my computer.	Audio output of the Button is not selected.	In Windows, left click on the speaker icon and select the ClickShare Speaker.
	ClickShare speaker is not selected as default device.	In Windows, right click on the speaker icon and select "Playback devices". In the Playback tab, right click on the ClickShare Speaker and select as "Default device", on the ClickShare Speakerphone if available, right click and select as "Default communications device".
Audio is heard in the room while not sharing on the big screen.	ClickShare speakerphone is selected as default device.	In Windows, right click on the speaker icon and select "Playback devices". In the Playback tab, right click on the ClickShare Speaker and select as "Default device", on the ClickShare Speakerphone if available, right click and select as "Default communications device".
Audio and video are not in sync.	ClickShare speakerphone is selected as audio device.	In Windows, left click on the speaker icon and select the ClickShare Speaker See also above for to select the ClickShare Speaker as default audio device.



# Environmental information

# 5

## 5.1 Disposal information

### Disposal Information

Waste Electrical and Electronic Equipment



■ This symbol on the product indicates that, under the European Directive 2012/19/EU governing waste from electrical and electronic equipment, this product must not be disposed of with other municipal waste. Please dispose of your waste equipment by handing it over to a designated collection point for the recycling of waste electrical and electronic equipment. To prevent possible harm to the environment or human health from uncontrolled waste disposal, please separate these items from other types of waste and recycle them responsibly to promote the sustainable reuse of material resources.

For more information about recycling of this product, please contact your local city office or your municipal waste disposal service.

For details, please visit the Barco website at: <http://www.barco.com/AboutBarco/weee>

### Disposal of batteries in the product



This product contains batteries covered by the Directive 2006/66/EC which must be collected and disposed of separately from municipal waste.

If the battery contains more than the specified values of lead (Pb), mercury (Hg) or cadmium (Cd), these chemical symbols will appear below the crossed-out wheeled bin symbol.

By participating in separate collection of batteries, you will help to ensure proper disposal and to prevent potential negative effects on the environment and human health.

## 5.2 Rohs compliance

### Turkey RoHS compliance



■ Türkiye Cumhuriyeti: AEEE Yönetmeliğine Uygunur.

[Republic of Turkey: In conformity with the WEEE Regulation]

### 中国大陆 RoHS – Chinese Mainland RoHS

根据中国大陆《电器电子产品有害物质限制使用管理办法》（也称为中国大陆RoHS），以下部分列出了Barco产品中可能包含的有毒和/或有害物质的名称和含量。中国大陆RoHS指令包含在中国信息产业部MCV标准：“电子信息产品中有毒物质的限量要求”中。

According to the “Management Methods for the Restriction of the Use of Hazardous Substances in Electrical and Electronic Products” (Also called RoHS of Chinese Mainland), the table below lists the names and contents of toxic and/or hazardous substances that Barco’s product may contain. The RoHS of Chinese Mainland is included in the MCV standard of the Ministry of Information Industry of China, in the section “Limit Requirements of toxic substances in Electronic Information Products”.

零件项目(名称) 有毒有害物质或元素  
Component Name Hazardous Substances or Elements

	铅 (Pb)	汞 (Hg)	镉 (Cd)	六价铬 (Cr6+)	多溴联苯 (PBB)	多溴二苯醚 (PBDE)
印制电路配件	x	0	x	0	0	0

Printed Circuit Assemblies 电(线)缆	x	0	x	0	0	0
Cables 底架	x	0	x	0	0	0
Chassis 电源供应器	x	0	x	0	0	0
Power Supply Unit 文件说明书	0	0	0	0	0	0
Paper Manuals						

本表格依据SJ/T 11364的规定编制

This table is prepared in accordance with the provisions of SJ/T 11364.

O: 表示该有毒有害物质在该部件所有均质材料中的含量均在 GB/T 26572 标准规定的限量要求以下。

O: Indicates that this toxic or hazardous substance contained in all of the homogeneous materials for this part is below the limit requirement in GB/T 26572.

X: 表示该有毒有害物质至少在该部件的某一均质材料中的含量超出 GB/T 26572 标准规定的限量要求。

X: Indicates that this toxic or hazardous substance contained in at least one of the homogeneous materials used for this part is above the limit requirement in GB/T 26572.

在中国大陆销售的相应电子信息产品（EIP）都必须遵照中国大陆《电子电气产品有害物质限制使用标识要求》标准贴上环保使用期限（EFUP）标签。Barco产品所采用的EFUP标签（请参阅实例，徽标内部的编号用于指定产品）基于中国大陆的《电子信息产品环保使用期限通则》标准。

All Electronic Information Products (EIP) that are sold within Chinese Mainland must comply with the “Marking for the restriction of the use of hazardous substances in electrical and electronic product” of Chinese Mainland, marked with the Environmental Friendly Use Period (EFUP) logo. The number inside the EFUP logo that Barco uses (please refer to the photo) is based on the “General guidelines of environment-friendly use period of electronic information products” of Chinese Mainland.



Image 5-1

## 限用物質含有情況標示聲明書 (Declaration of the Presence Condition of the Restricted Substances Marking) — Taiwan RoHS compliance

設備名稱： 影音共享控制中心， 型號（型式）： CSE-800

Equipment name: wireless presentation system, Type designation: CSE-800

單元 Unit	限用物質及其化學符號 Restricted substances and its chemical symbols					
	鉛 Lead (Pb)	汞 Mercury (Hg)	鎘 Cadmium (Cd)	六價鉻 Hexavalent chromium (Cr6+)	多溴聯苯 Poly- brominat- ed biphenyl (PBB)	多溴二苯醚 Poly- brominated diphenyl ethers (PBDE)
電路板 Printed Circuit Assemblies	—	0	—	0	0	0

電 (線) 纜 Cables	—	○	—	○	○	○
機箱 Chassis	—	○	—	○	○	○
電源供應器 Power Supply Unit	—	○	○	○	○	○

備考1. “超出0.1 wt %”及“超出0.01 wt %”係指限用物質之百分比含量超出百分比含量基準值。

Note 1 : “Exceeding 0.1 wt %” and “exceeding 0.01 wt %” indicate that the percentage content of the restricted substance exceeds the reference percentage value of presence condition.

備考2. “○”係指該項限用物質之百分比含量未超出百分比含量基準值。

Note 2 : “○” indicates that the percentage content of the restricted substance does not exceed the percentage of reference value of presence.

備考3. “—”係指該項限用物質為排除項目。

Note 3 : The “—” indicates that the restricted substance corresponds to the exemption.

## 5.3 Production address

### Factory

Barco N.V.  
12F, Citychamp Building, No. 12, Tai Yang Gong Zhong Lu, Chaoyang District, Beijing, P.R.C

### Made in information

The made in country is indicated on the product ID label on the product itself.

### Production date

The month and year of production is indicated on the product ID label on the product itself.

## 5.4 Importers contact information

### Contact

To find your local importer, contact Barco directly or one of Barco's regional offices via the contact information given on Barco's web site, [www.barco.com](http://www.barco.com).



**BARCO**

 **UniKomp**

Nowe Technologie IT

**Gold partner**

43-200 Pszczyna, ul. Dworcowa 8  
tel. (32) 210 22 11, 326 33 00  
barco@unikomp.pl  
www.unikomp.pl



R5900095 /05 | 2020-09-16

Barco NV | Beneluxpark 21, 8500 Kortrijk, Belgium  
Registered office: Barco NV | President Kennedypark 35, 8500 Kortrijk, Belgium  
[www.barco.com](http://www.barco.com)